

Samet + Samet Low Collection



GERVASONI

1882

Samet+
Samet Low

Collection
by Federica Biasi

Gervasoni 1882





I. Samet è un divano componibile senza regole, un prodotto polifunzionale e configurabile che pone l'uomo come soggetto attivo nella composizione del proprio spazio, incoraggiandolo a sperimentare nuove forme di utilizzo. Sedute accoglienti e ospitali si accostano l'una all'altra in geometrie regolari e morbide, un progetto dinamico per creare molteplici tipologie di sedute più o meno informali. Dettagli, impunture e matelassé, arricchiscono una semplice modulistica che crea infinite composizioni con un'estetica oltre tempo, dal sofà più classico a quello più poliedrico.

E. Samet is a modular sofa without rules, a multifunctional and modular product that places man as an active subject in the composition of his own space, encouraging him to experiment with new forms of use. Cozy and comfortable seats are combined each other in regular and soft geometries, a dynamic design to create multiple types of elegant or informal seating in the same time. Details, stitching and matelassé enrich the collection creating ever-new compositions with a timeless aesthetic, from the most classic sofa to the most eclectic.

F. Samet est un canapé modulaire sans règles, un produit multifonctionnel et configurable qui place la personne en tant que sujet actif dans la composition de son propre espace, en l'encourageant à expérimenter de nouvelles formes d'utilisation. Des sièges confortables et accueillants sont juxtaposés les uns aux autres dans des géométries régulières et douces, un design dynamique pour créer de multiples types de sièges plus ou moins informels. Détails, coutures et éléments matelassés enrichissent une modularité simple qui crée des compositions infinies à l'esthétique intemporelle, du canapé le plus classique au plus multiforme.

D. Samet ist ein modulares Sofa ohne Regeln, ein multifunktionales und konfigurierbares Produkt, das den Menschen als aktives Subjekt in die Gestaltung seines eigenen Raums einbezieht und ihn ermutigt, neue Verwendungsmöglichkeiten Nutzungsformen zu experimentieren. Gemütliche und einladende Sitzelemente werden in regelmäßigen und weichen Geometrien einander gegenübergestellt, ein dynamisches Design, um verschiedene Arten von mehr oder weniger informellen Sitzgelegenheiten zu schaffen. Details, Nähte und Steppauflagen bereichern eine einfache Modularität, die unendliche Kompositionen mit einer zeitlosen Ästhetik schafft, vom klassischsten Sofa bis zum Allrounder Teil.

Index:

1. Samet

Configuration A
010 – 017
Configuration B
018 – 025
Configuration D
026 – 033
Configuration E
034 – 041
Configuration F
042 – 047
Configuration G
048 – 055
Configuration H
056 – 063
Configuration I
064 – 069
Other elements
070 – 075

2. Samet Low

Configuration A
078 – 085
Configuration B
086 – 093
Configuration C
094 – 101
Configuration D
102 – 107
Configuration E
108 – 115
Configuration F
116 – 121

3. Samet Technical Details 123

4. Samet Low Technical Details 129



Samet Configurations



Samet Configuration A





Samet Configuration A





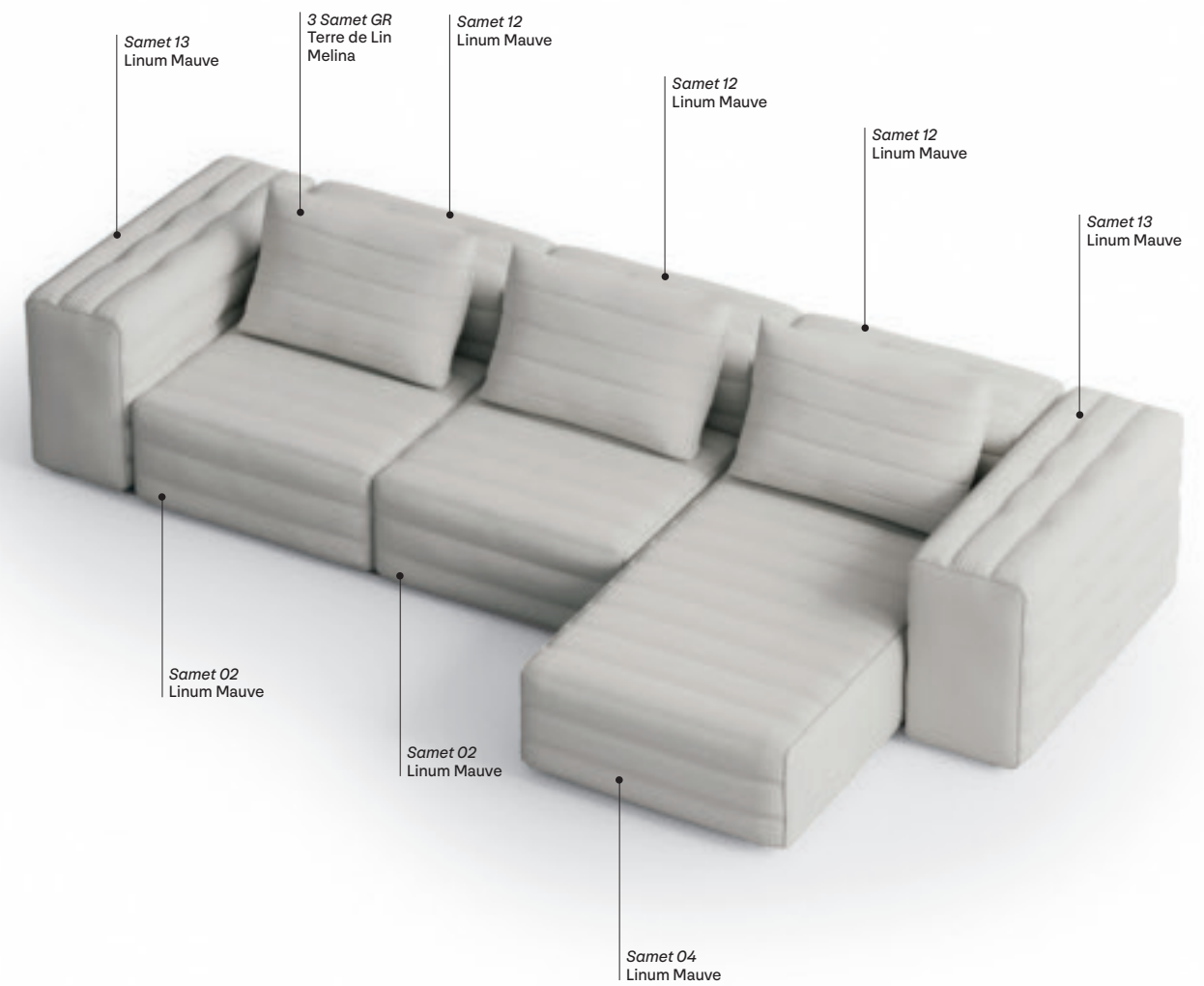

Samet Configuration A



Composizione / Configuration

Misure / Measures

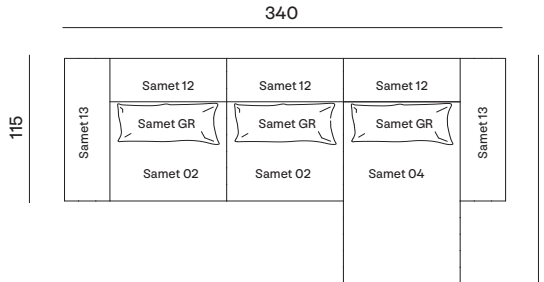
[Technical Details p. 127]

 <p>Linum Mauve - C</p>	 <p>Terre de Lin Melina - B</p>		
<p>Cuscini Extra / Loose Cushions</p>			
<p>2 C. Samet XS</p>			
 <p>Sand Pollara - C</p>			

Samet Configuration B





Samet Configuration B





Samet Configuration B



Composizione / Configuration

Misure / Measures

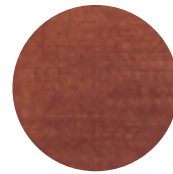
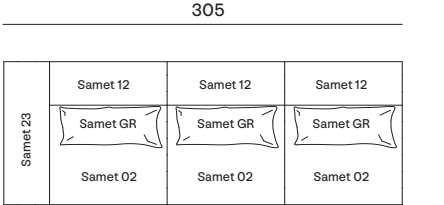
[Technical Details p. 127]

 Artist Monet - C	 Sand Majore - C		
Cuscini Extra / Loose Cushions			
2 C. Samet XS			
 Sand Pollara - C			

Samet Configuration D





Samet Configuration D



030



031

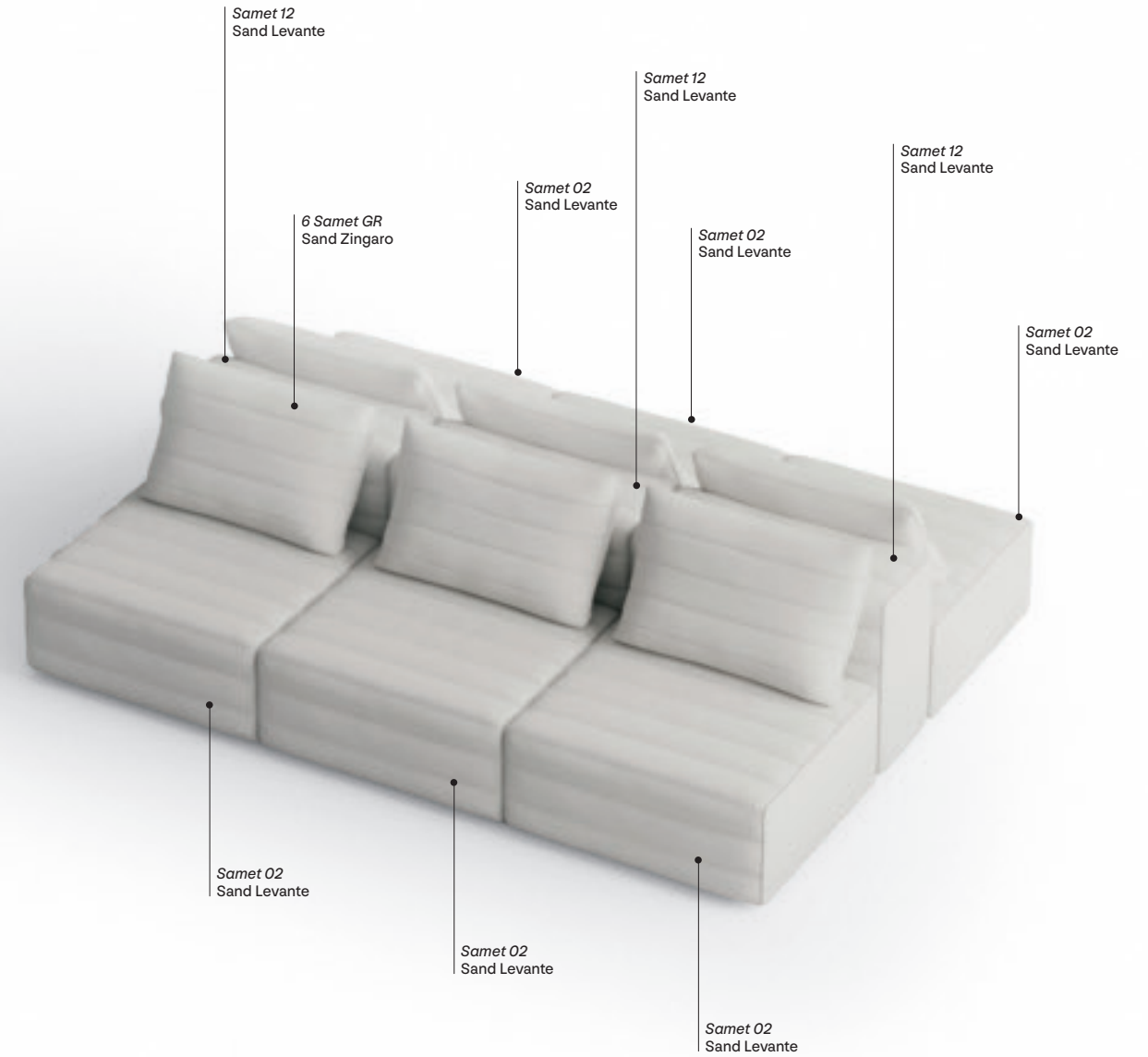

Samet – Configuration D



Composizione / Configuration

Misure / Measures

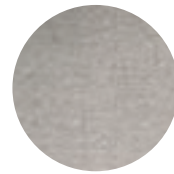
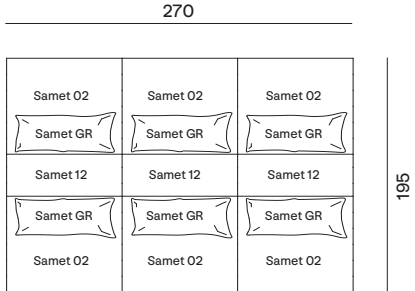
[Technical Details p. 127]

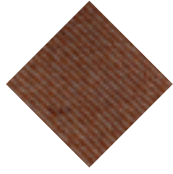
 Sand Levante - C	 Sand Zingaro - C		
Cuscini Extra / Loose Cushions			
1 C. Samet XS	1 C. Samet XS	2 C. Samet XS	
 Terre de Lin Cirrus - B	 Sand Marinella - C	 Tweel Quair - C	

Samet Configuration E





Samet Configuration E



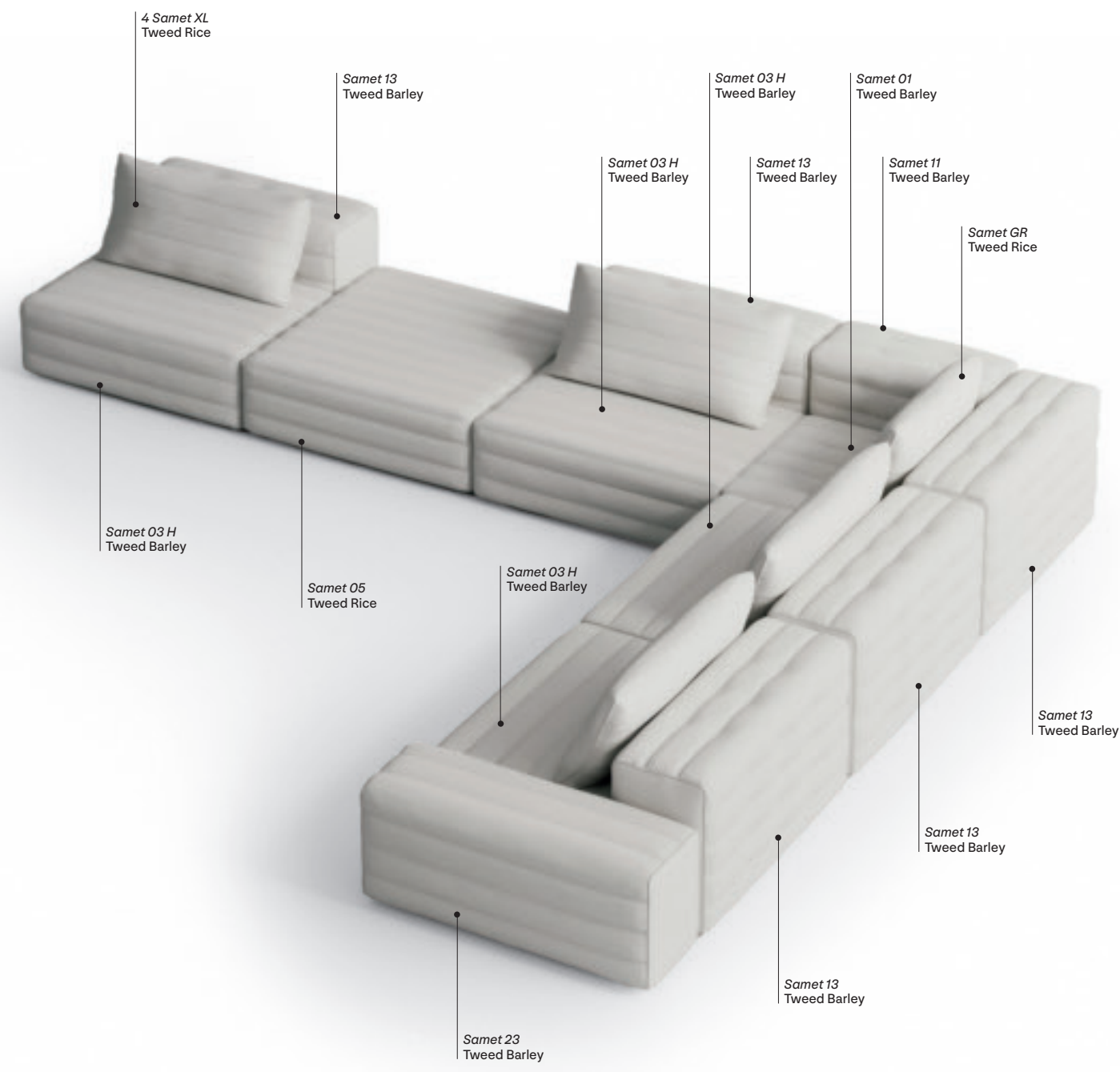



Composizione / Configuration

Misure / Measures

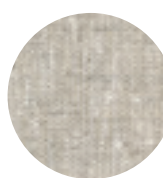
[Technical Details p. 127]

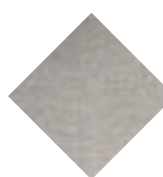
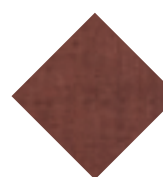
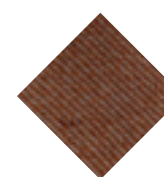
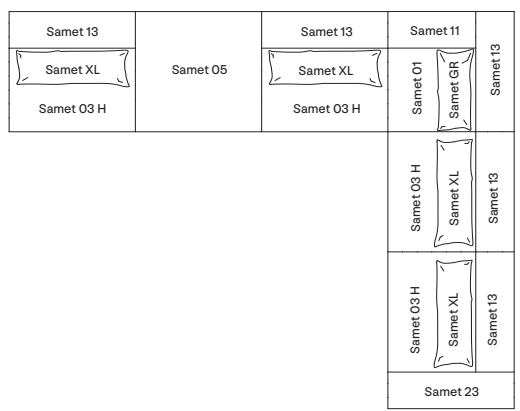
 <p>Tweed Barley - D</p>		 <p>Tweed Rice - D</p>			
Cuscini Extra / Loose Cushions					
1 C. Samet XS		1 C. Samet XS		2 C. Samet XS	
 <p>Sand Zingaro - C</p>		 <p>Terre de Lin Vesta - B</p>		 <p>Tweel Quair - C</p>	
				<p style="text-align: center;">460</p> 	
				380	



Samet Configuration F



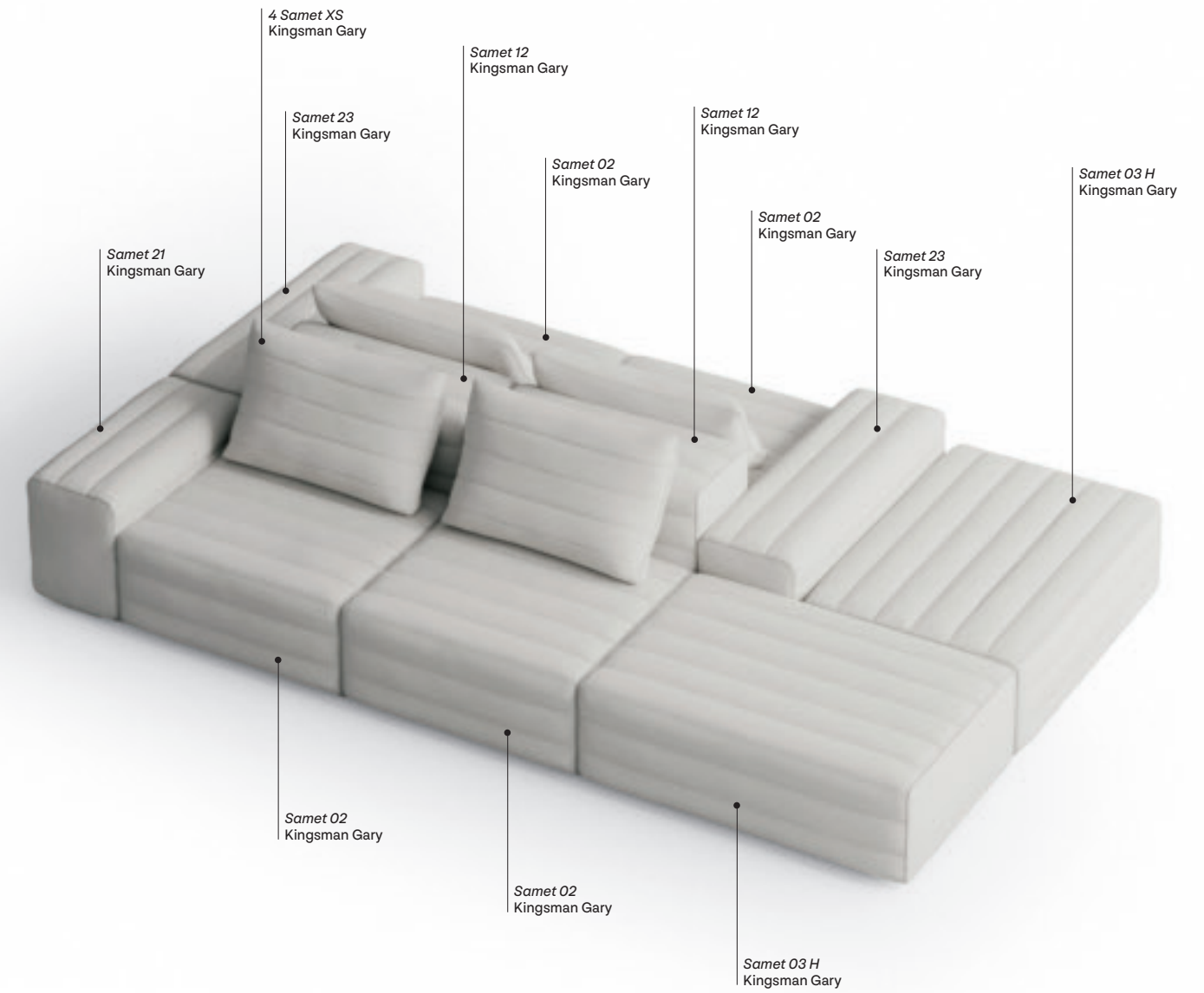

Samet Configuration F



Composizione / Configuration

Misure / Measures

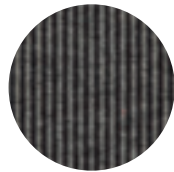
[Technical Details p. 127]

 <p>Kingsman Gary - C</p>																										
Cuscini Extra / Loose Cushions																										
2 C. Samet XS																										
 <p>Sand Majore - C</p>																										
			<p style="text-align: center;">330</p> <table border="1" style="width: 100%; height: 100%;"> <tr> <td style="width: 10%; text-align: center;">Samet 23</td> <td style="width: 20%; text-align: center;">Samet 02 Samet GR</td> <td style="width: 20%; text-align: center;">Samet 02 Samet GR</td> <td style="width: 10%; text-align: center;">Samet 23</td> <td style="width: 30%; text-align: center;">Samet 03 H</td> </tr> <tr> <td></td> <td style="text-align: center;">Samet 12</td> <td style="text-align: center;">Samet 12</td> <td></td> <td></td> </tr> <tr> <td style="text-align: center;">Samet 21</td> <td style="text-align: center;">Samet GR</td> <td style="text-align: center;">Samet GR</td> <td></td> <td style="text-align: center;">Samet 03 H</td> </tr> <tr> <td></td> <td style="text-align: center;">Samet 02</td> <td style="text-align: center;">Samet 02</td> <td></td> <td></td> </tr> </table> <p style="text-align: right; margin-right: 10px;">195</p>				Samet 23	Samet 02 Samet GR	Samet 02 Samet GR	Samet 23	Samet 03 H		Samet 12	Samet 12			Samet 21	Samet GR	Samet GR		Samet 03 H		Samet 02	Samet 02		
Samet 23	Samet 02 Samet GR	Samet 02 Samet GR	Samet 23	Samet 03 H																						
	Samet 12	Samet 12																								
Samet 21	Samet GR	Samet GR		Samet 03 H																						
	Samet 02	Samet 02																								

Samet

Configuration G





Samet Configuration G



052



053

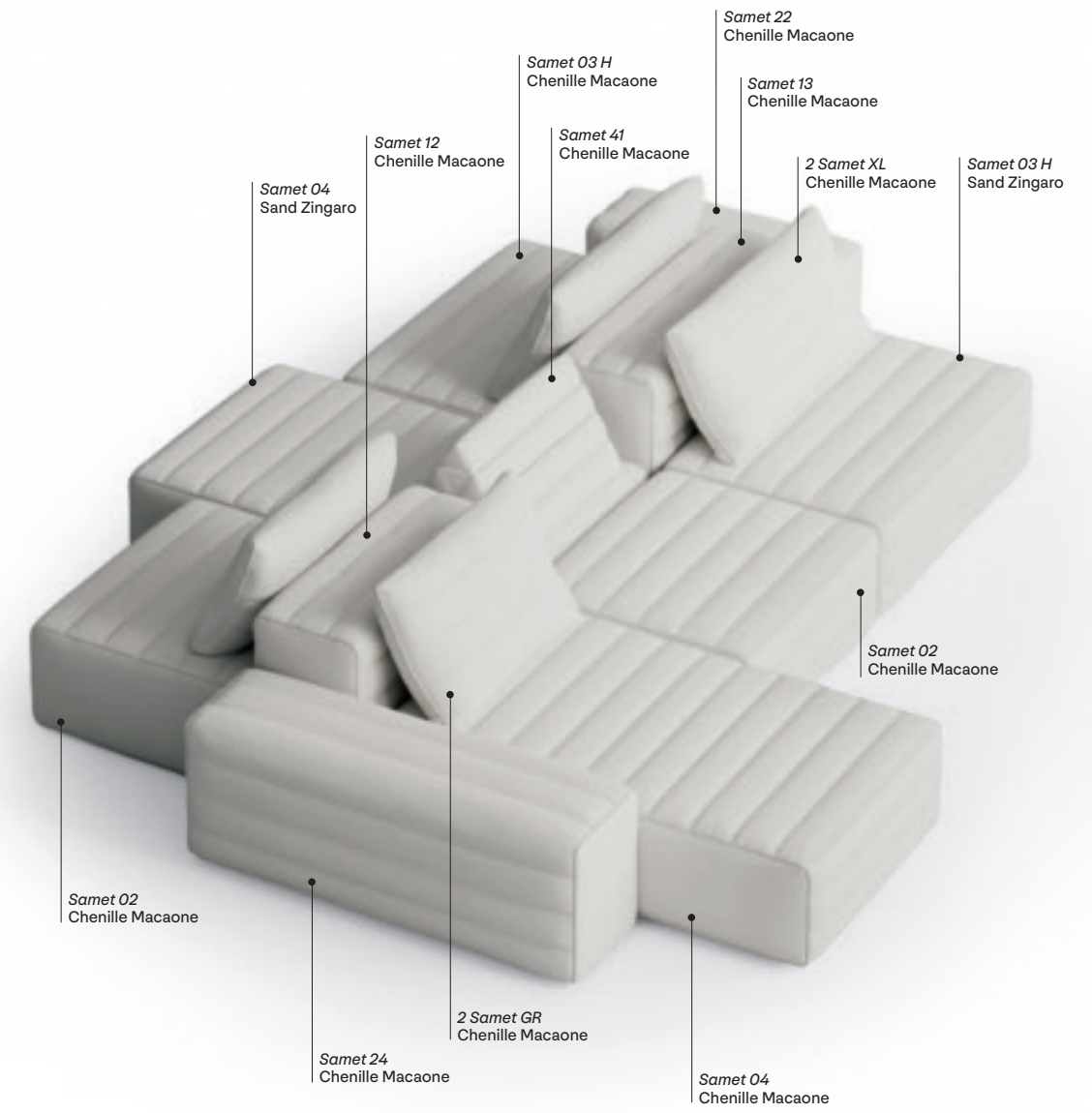

Samet – Configuration G



Composizione / Configuration

Misure / Measures

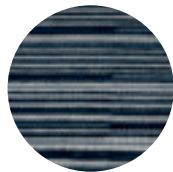
[Technical Details p. 128]

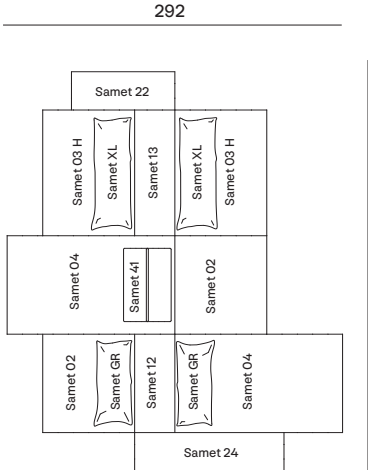
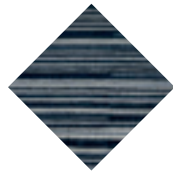
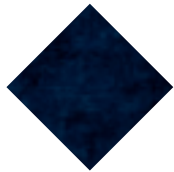
 <p>Chenille Macaone - C</p>		 <p>Sand Zingaro - C</p>		
<p>Cuscini Extra / Loose Cushions</p>				
<p>1 C. Samet XS</p>		<p>2 C. Samet M</p>		
 <p>Chenille Macaone - C</p>		 <p>Deus Saturno - C</p>		



Samet Configuration H



Samet Configuration H



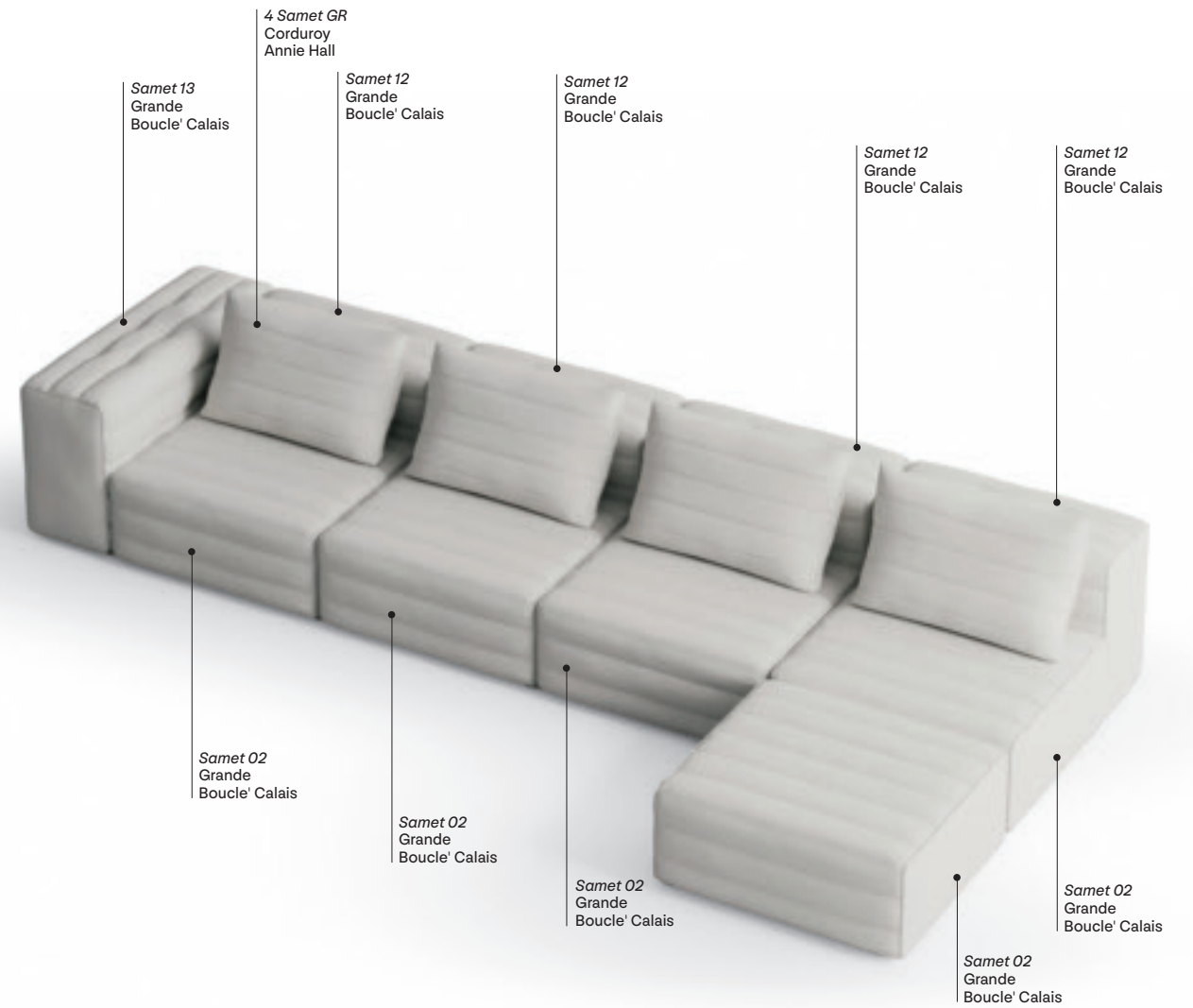

Composizione / Configuration

Misure / Measures

[Technical Details p. 128]

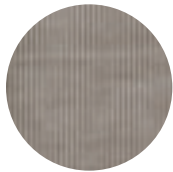
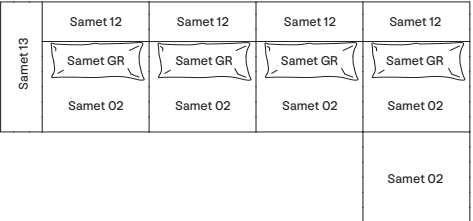
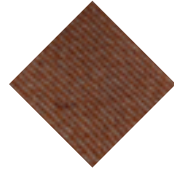
 Grande Boucle' Calais - D	 Corduroy Annie Hall - C		395				
Cuscini Extra / Loose Cushions							
2 C. Samet XS							
 Tweel Quair - C							

Samet Configuration I





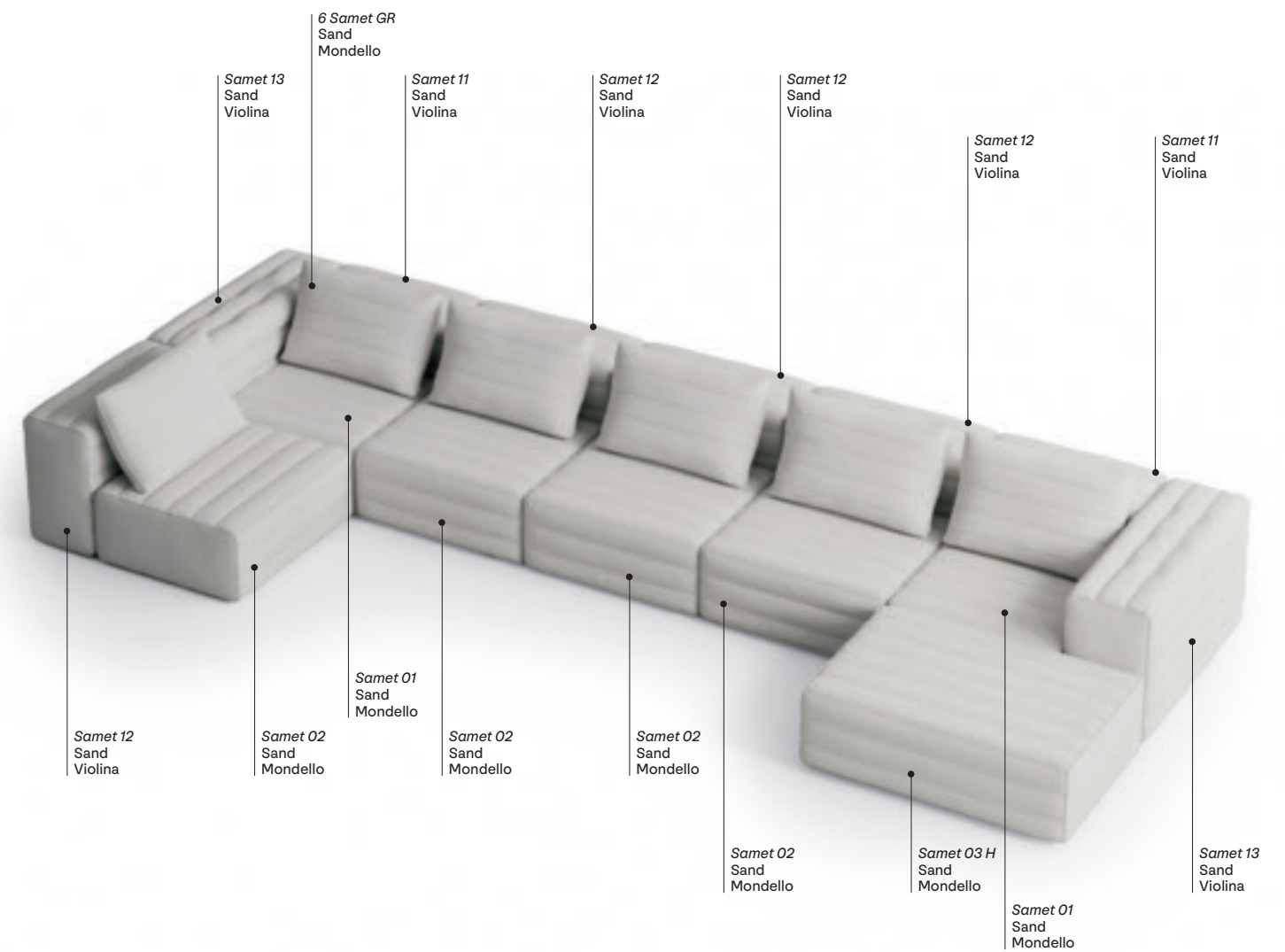





Composizione / Configuration

Misure / Measures

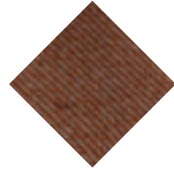
[Technical Details p. 128]

 Sand Violina - C	 Sand Mondello - C		500							
Cuscini Extra / Loose Cushions										
2 C. Samet XS	1 C. Samet XS		205	Samet 11	Samet 12	Samet 12	Samet 12	Samet 11	Samet 13	195
			Samet 13	Samet GR	Samet GR	Samet GR	Samet GR	Samet GR	Samet 13	
			Samet 12	Samet 01	Samet 02	Samet 02	Samet 02	Samet 01	Samet 03 H	
 Tweel Quair - C	 Sand Majore - C									



Samet Other Elements





Composizione / Configuration

Misure / Measures

[Technical Details p.125, 126]

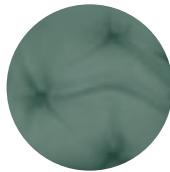
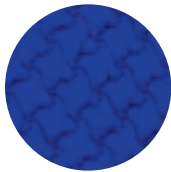
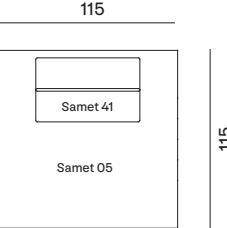
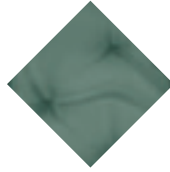
 <p>Quilt Velour Lake - D</p>	 <p>3D Blu - E</p>		
<p>Cuscini Extra / Loose Cushions</p>			
<p>1 C. Samet XS</p>			
 <p>Quilt Velour Lake - D</p>			

Samet Low Configurations



Samet Low Configuration A





Samet Low Configuration A



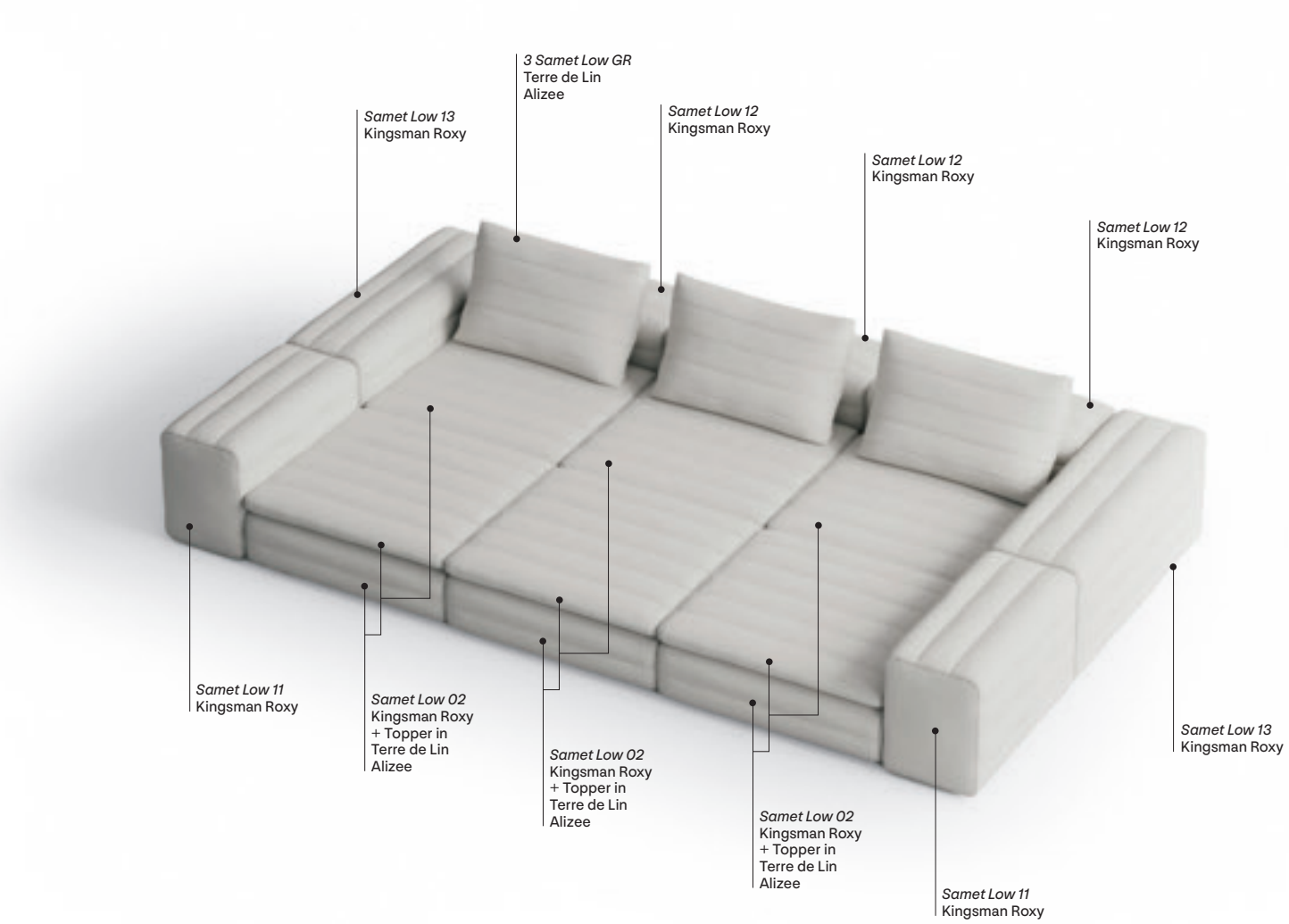

Composizione / Configuration

Misure / Measures

[Technical Details p.133]

Kingsman Roxy - C	Terre de Lin Alizee - B	
Cuscini Extra / Loose Cushions		
1 C. Samet Low XS	1 C. Samet Low XS	1 C. Samet Low M
Chenille Macaone - C	Deus Mercurio - C	Deus Saturno - C
1 C. Samet Low XS	1 C. Samet Low XS	
Sand Pollara - C	Terre de Lin Alizee - B	

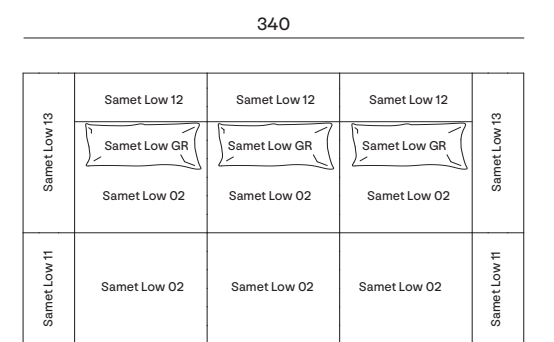

Samet Low Configuration B







Samet Low 03 H

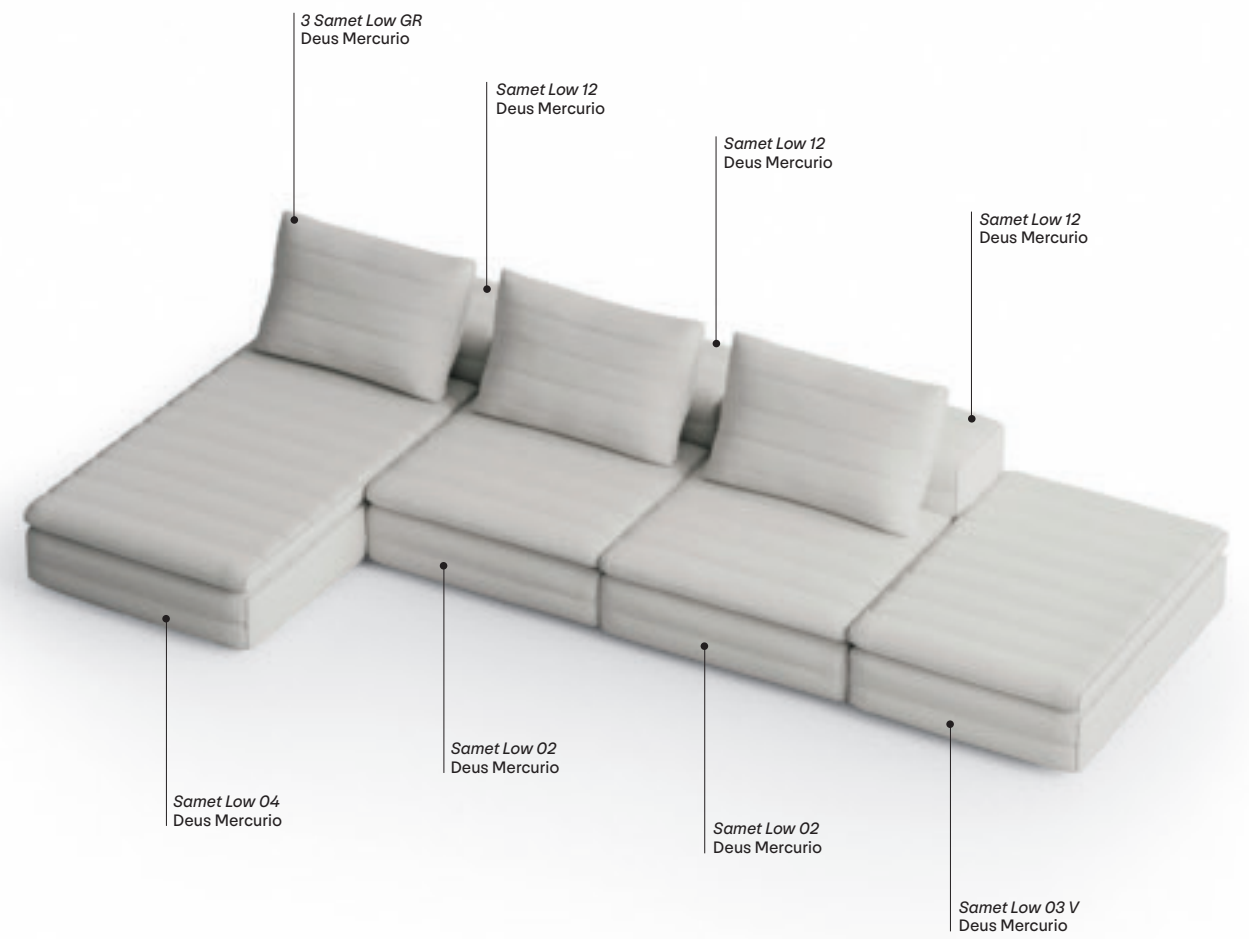

Samet Low Configuration B



Composizione / Configuration

Misure / Measures

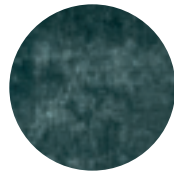
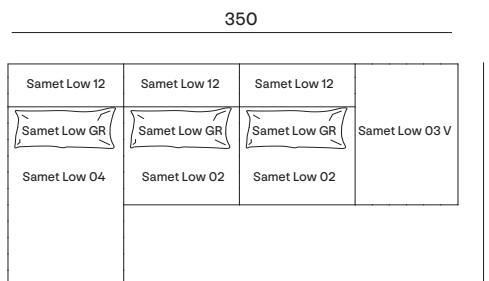
[Technical Details p. 133]

 Deus Mercurio - C						
Cuscini Extra / Loose Cushions			<div style="text-align: center;">350</div> 			
1 C. Samet Low XS						181
 Sand Majore - C						

Samet Low Configuration C





Samet Low Configuration C



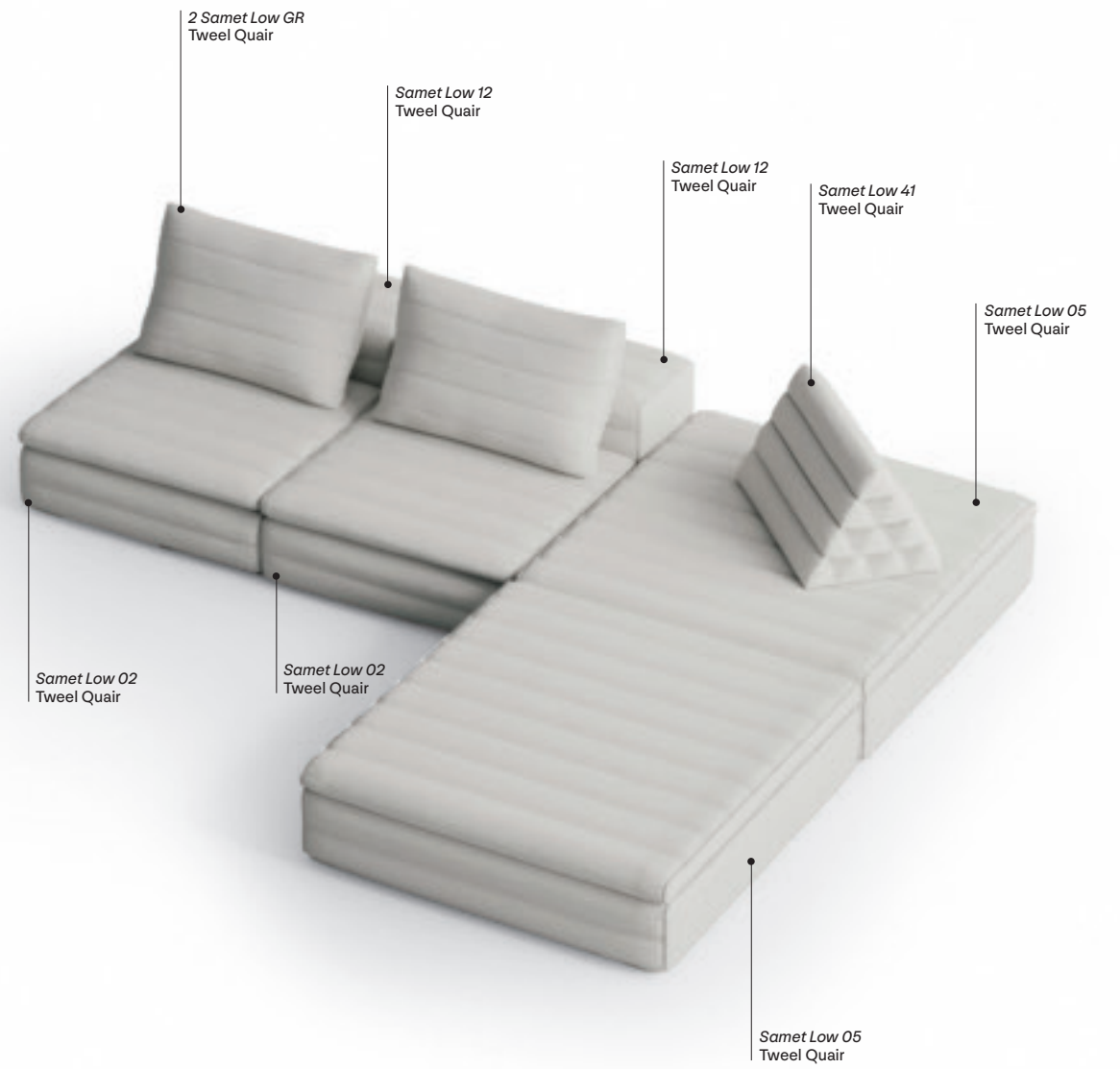

Composizione / Configuration

Misure / Measures

[Technical Details p. 133]

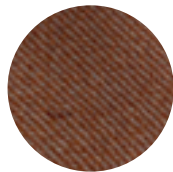
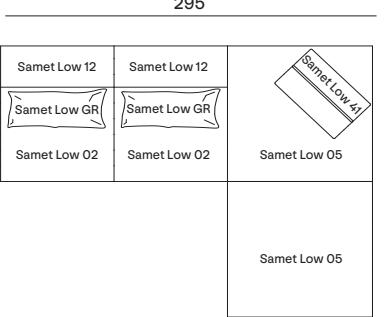
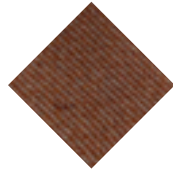
 <p>Tweel Quair - C</p>			<div style="text-align: center;">295</div> 
<p>Cuscini Extra / Loose Cushions</p> <p>2 C. Samet Low XS</p>			
 <p>Tweel Quair - C</p>			

Samet Low Configuration D



103



↑ 1 Samet Low 04 in Tweel Eddeleston – C; 1 Samet Low 41 in Terre de Lin Damara – B.
1 Samet Low 05 in Terre de Lin Melina – B; 1 Samet Low 41 in Terre de Lin Melina – B.
1 Samet Low 05 in Terre de Lin Melina – B.



↑ 1 Samet Low 04 in Tweel Eddelston – C; 1 Samet Low 41 in Terre de Lin Melina – B.
 1 Samet Low 05 in Terre de Lin Melina – B; 1 Samet Low 41 in Terre de Lin Damara – B.

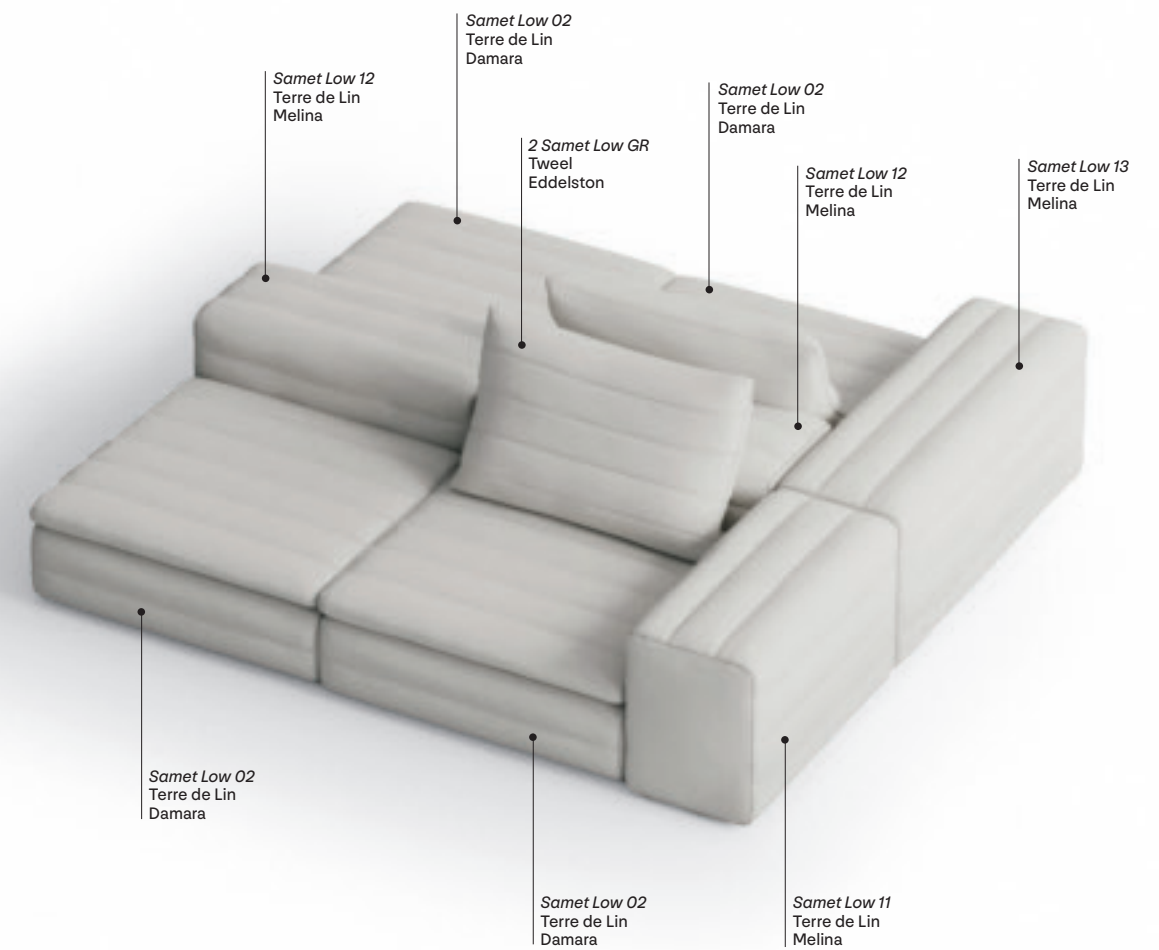

Composizione / Configuration

Misure / Measures

[Technical Details p. 133]

 Terre de Lin Damara - B	 Terre de Lin Melina - B	 Tweel Eddelston - C	215 
Cuscini Extra / Loose Cushions			
1 C. Samet Low M			
 Chenille Macaone - C			195

Samet Low Configuration E







Samet Low Configuration E

Samet Low 81

Samet Low 81



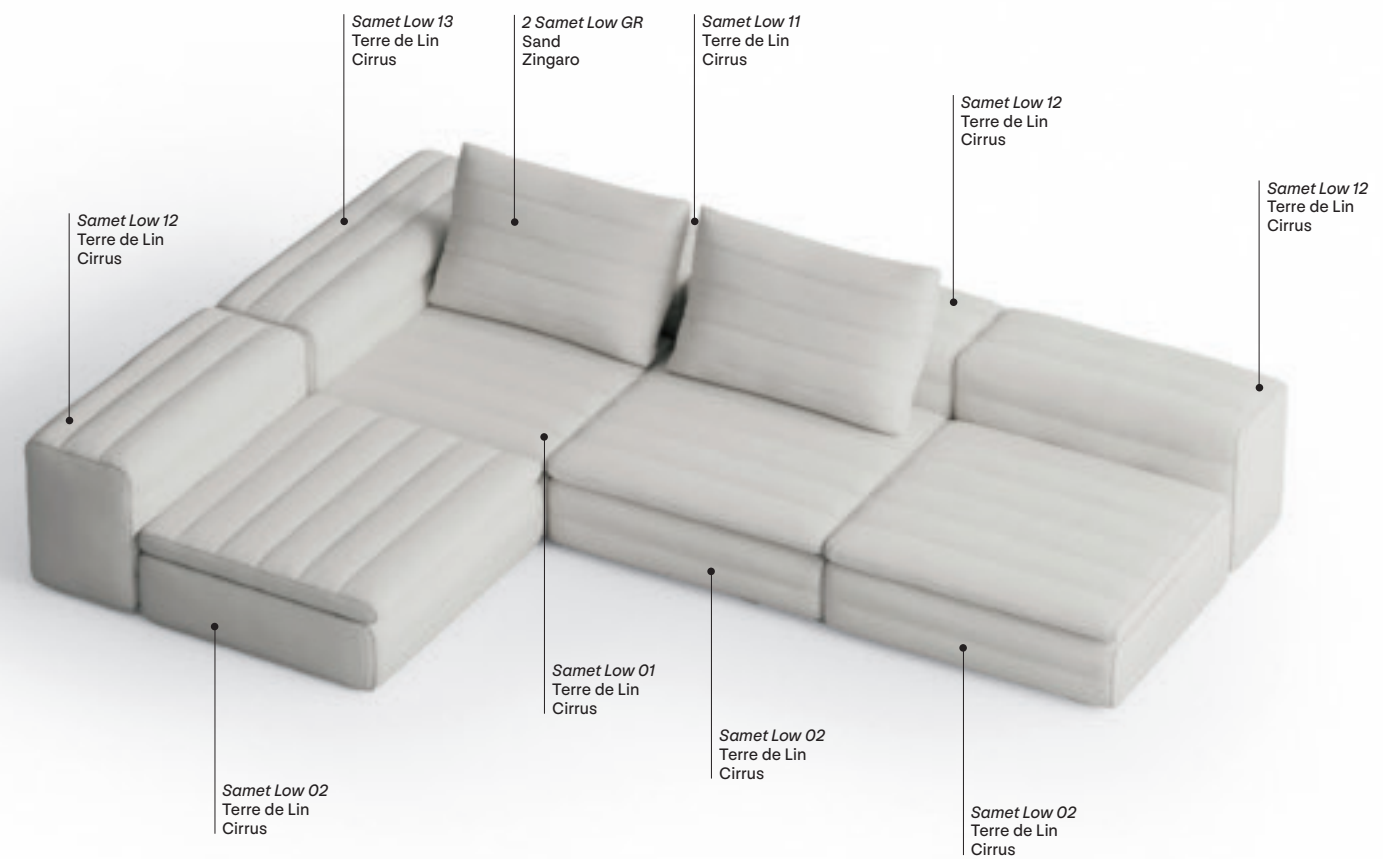

↑ 1 Samet Low 81 in Sand Zingaro – C.
1 Samet Low 81 in Sand Levante – C; 1 C. Samet Low XS in Sand Marinella – C.



Composizione / Configuration

Misure / Measures

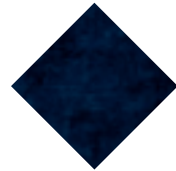
[Technical Details p. 133]

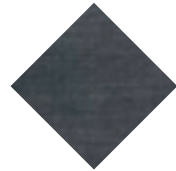
 Terre de Lin Cirrus - B	 Sand Zingaro - C		295			
Cuscini Extra / Loose Cushions						
2 C. Samet Low M	2 C. Samet Low XS	2 C. Samet Low XS	Samet Low 13	Samet Low 11	Samet Low 12	Samet Low 12
			Samet Low GR	Samet Low GR		Samet Low 02
			Samet Low 01	Samet Low 02		Samet Low 02
 Deus Saturno - C	 Sand Marinella - C	 Sand Pollara - C	Samet Low 12	Samet Low 02		205

Samet Low Configuration F





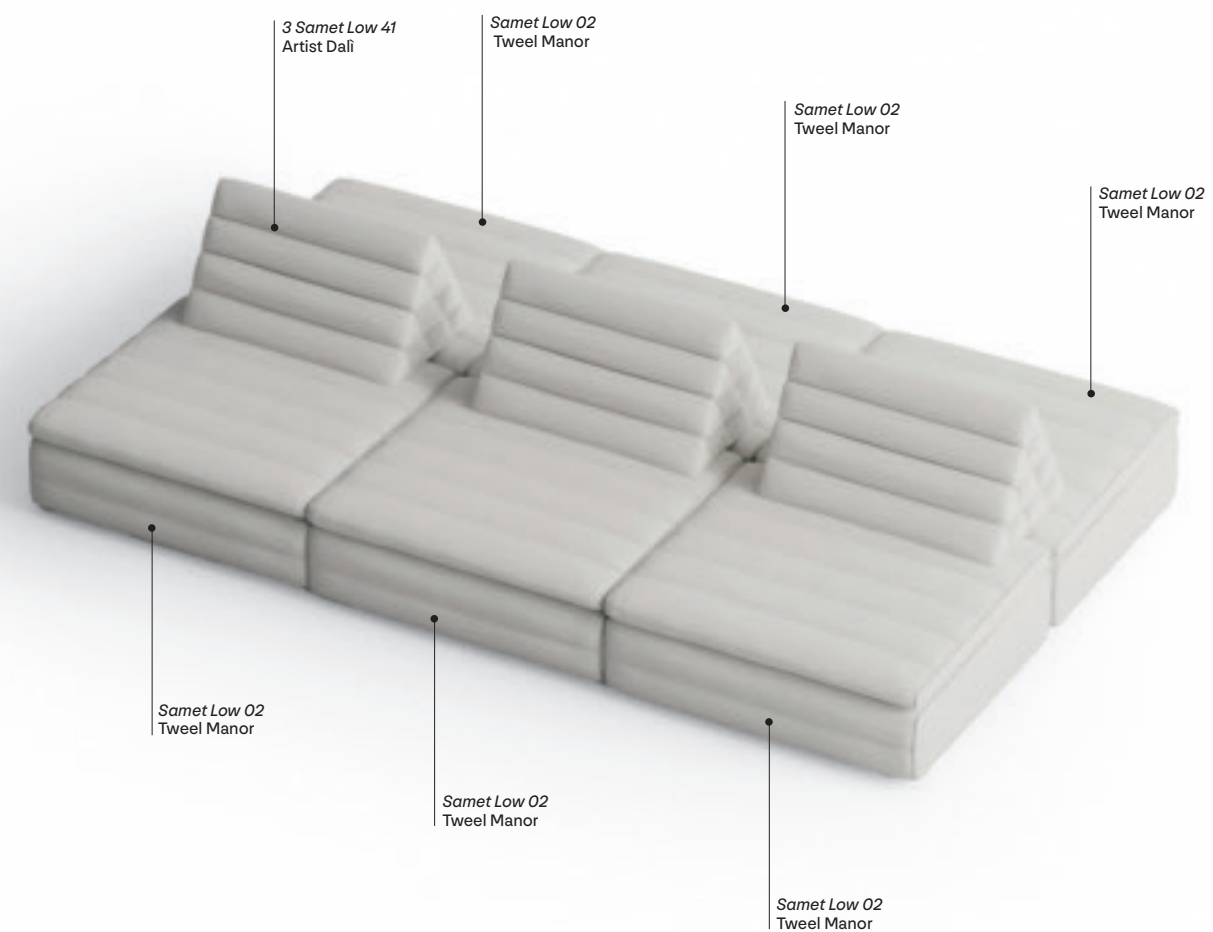

Samet Low Configuration F



Composizione / Configuration

Misure / Measures

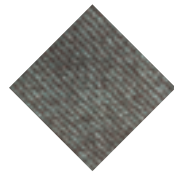
[Technical Details p. 133]

 Tweed Manor - C	 Artist Dali - C		<div style="display: flex; align-items: center; justify-content: center;"> <div style="border: 1px solid black; padding: 5px; margin: 2px;">Samet Low 02</div> <div style="border: 1px solid black; padding: 5px; margin: 2px;">Samet Low 02</div> <div style="border: 1px solid black; padding: 5px; margin: 2px;">Samet Low 02</div> </div> <div style="display: flex; align-items: center; justify-content: center; margin: 2px;"> <div style="border: 1px solid black; padding: 5px; margin: 2px;">Samet Low 41</div> <div style="border: 1px solid black; padding: 5px; margin: 2px;">Samet Low 41</div> <div style="border: 1px solid black; padding: 5px; margin: 2px;">Samet Low 41</div> </div> <div style="display: flex; align-items: center; justify-content: center;"> <div style="border: 1px solid black; padding: 5px; margin: 2px;">Samet Low 02</div> <div style="border: 1px solid black; padding: 5px; margin: 2px;">Samet Low 02</div> <div style="border: 1px solid black; padding: 5px; margin: 2px;">Samet Low 02</div> </div> <div style="margin-left: 10px;">270</div> <div style="margin-left: 10px; border-left: 1px solid black; height: 80px; display: flex; align-items: center; justify-content: center;">160</div>
Cuscini Extra / Loose Cushions			
2 C. Samet Low XS			
 Sand Pollara - C			



Samet

Technical Details

Sezione Samet / Samet Section

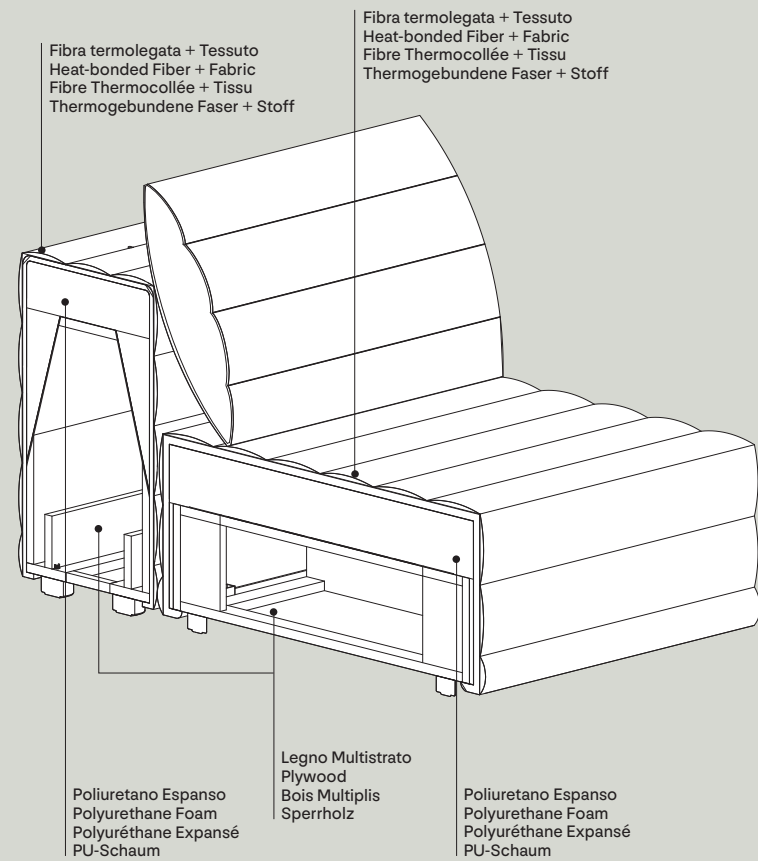

Struttura / Structure / Structure / Gestell

Struttura in legno multistrato preparata con poliuretano espanso a quote differenziate, localizzate, ad alta densità, al fine di migliorarne comfort, soffici ta e durata. Rivestimento della struttura in fibra termolegata traspirante accoppiata alla fodera in tessuto tramite trapuntatura. Piedi in polietilene ad alta resistenza, colore nero.

Structure in plywood made of high resilience, variable-density polyurethane foam, in order to improve comfort, softness and durability. Structure covered with breathable, heat-bonded fiber coupled with fabric cover by quilting. Feet in high resistance black polyethylene.

Structure en bois multiplis associ e   du polyur thane expans    densit  diff renci e haute r silience, garantissant confort, souplesse et long vit . Rev tement de la structure en fibre thermocoll e respirante li e   la housse en tissu matelass . Pieds en poly thyl ne haute r sistance, couleur noire.

Gestell aus Sperrholz, Polsterung aus PU-Schaum mit differenzierter, hoher Dichte, um Komfort, Weichheit und Langlebigkeit zu gew hrleisten. Wei polsterbezug mit atmungsaktiver thermogebundener Faser gesteppt zusammen mit der Husse aus Stoff. Schwarze F  e aus widerstandsf higem Polyethylen.

Cuscini / Cushions / Coussins / Kissen

I cuscini di schienale sono realizzati in fibra di poliestere di alta qualit  che assicura il ripristino della forma originaria del cuscino dopo l'uso. Fodera in tessuto e fibra, trapuntate sul lato anteriore. Cuscini volanti con imbottitura in misto piuma.

Back cushions are made of high-quality polyester fiber, which ensures that the original shape of the pillow is restored after use. Fabric and fiber cover, quilted on the front side. Loose cushions with dacron and down filling.

Les coussins de dossier sont r alis s en fibres de polyester de haute qualit , ce qui permet de retrouver la forme originale du coussin apr s utilisation. Housse en tissu et en fibres, matelass e sur le devant. Coussins d co avec rembourrage en dacron et plumes.

Die R ckenkissen sind aus hochwertigen Polyesterfasern, die daf r sorgen, dass das Kissen nach dem Gebrauch seine urspr ngliche Form wieder erh lt. Kissenbezug aus Stoff und Fasern, auf der Vorderseite gesteppt. Lose Kissen mit Polsterung aus Dacron und Daunen.

Sfoderabilit  / Removable covers / Housses amovibles / Abnehmbare Bez ge:

Ogni modulo   facilmente sfoderabile a garanzia di una facile e frequente pulizia del rivestimento.

Each module is completely and easily removable to guarantee easy and frequent cleaning of the cover.

Chaque  l ment est enti rement et facilement d houssable permettant un nettoyage ais  et fr quent des housses.

Alle Elemente sind komplett abziehbar, was eine einfache und h ufige Reinigung der Bez ge garantiert.

Samet 01 Samet 02 Samet 03 H

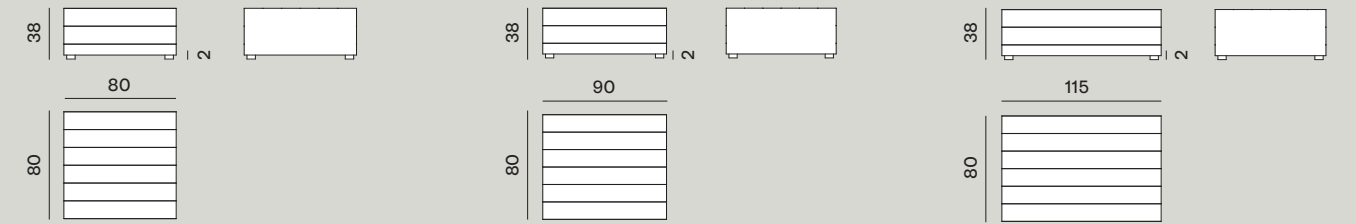

Samet 03 V Samet 04 Samet 05

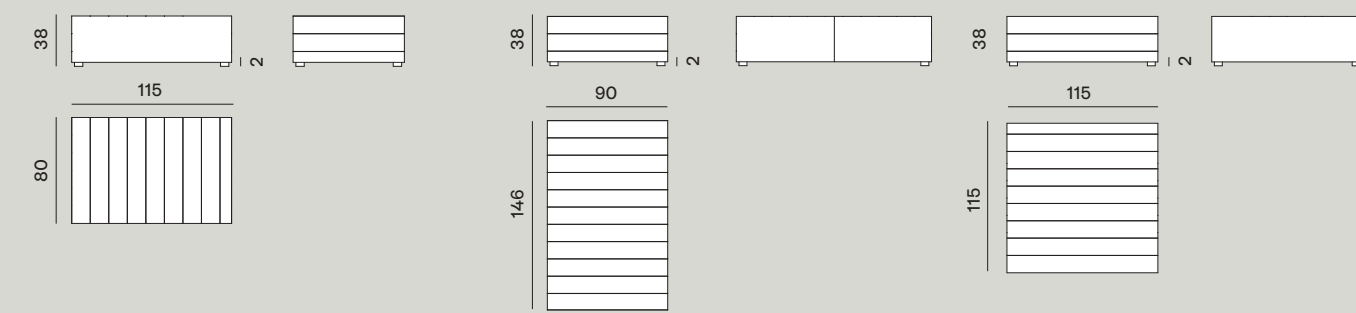

Samet 11 Samet 12 Samet 13

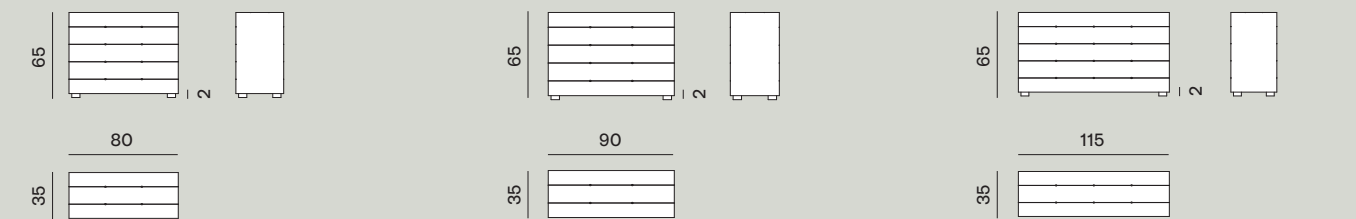

Samet 21 Samet 22 Samet 23

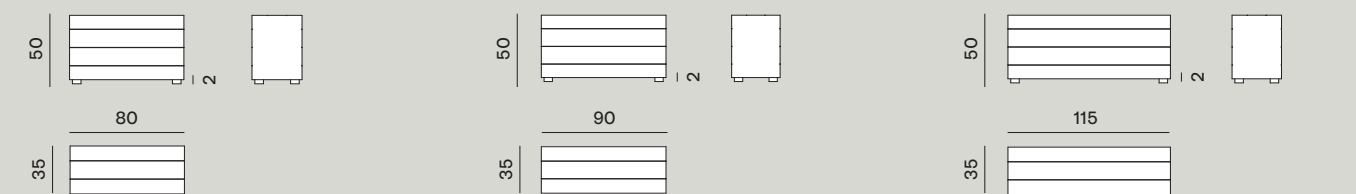

↳ Samet Modules

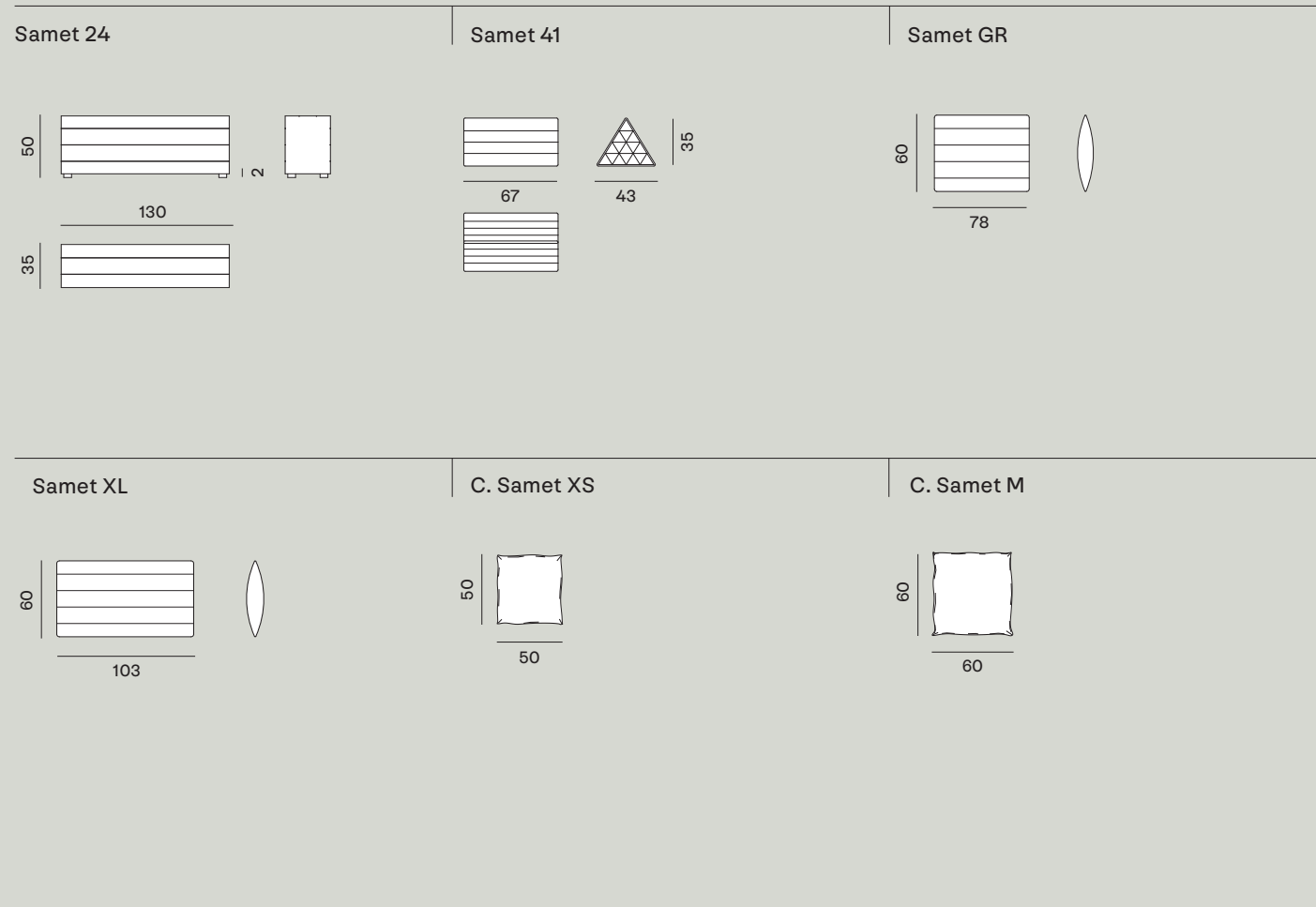

↳ Samet Configurations

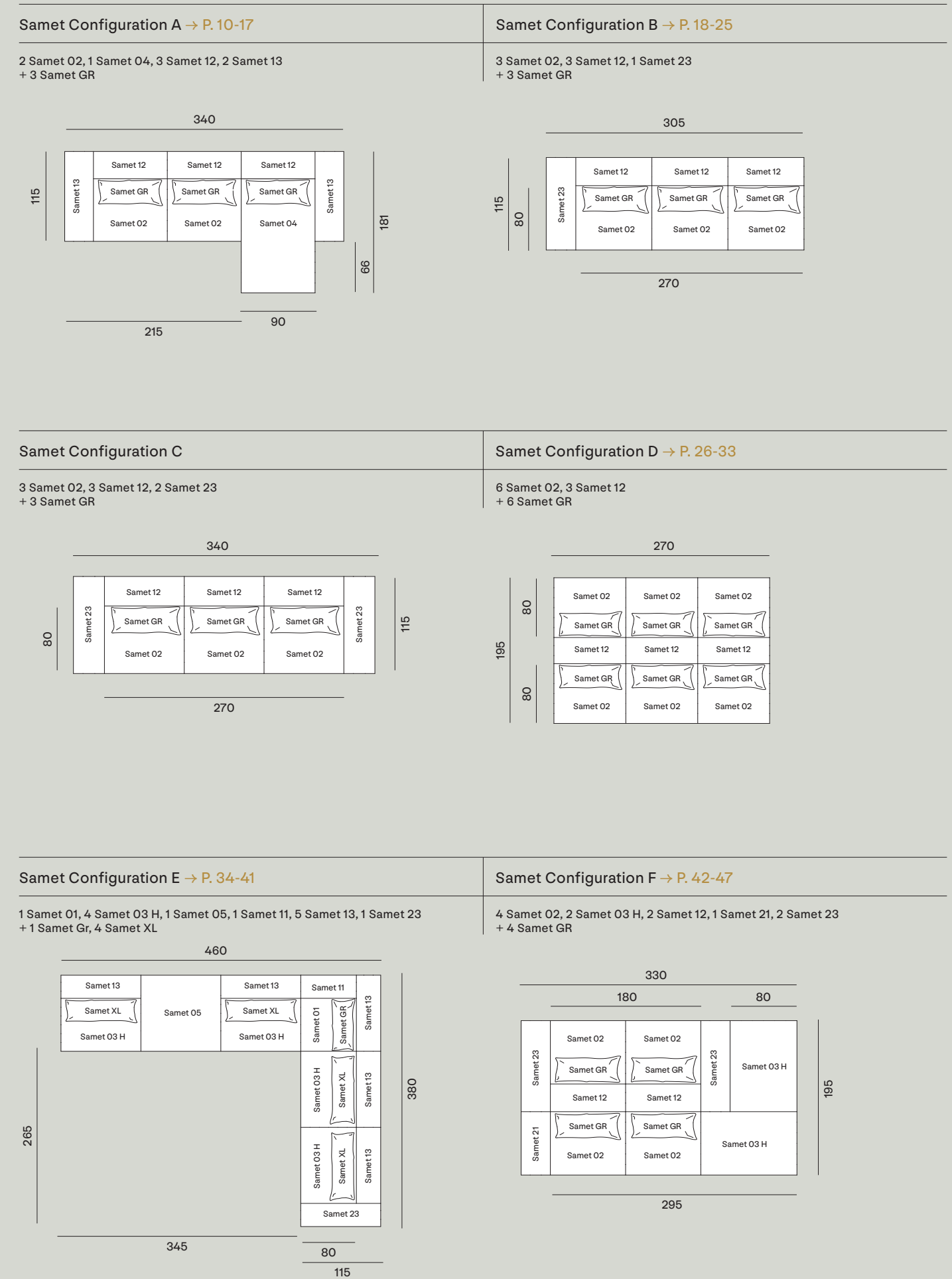

Samet Low Technical Details

Samet Configuration G → P. 48-55

2 Samet O2, 2 Samet O3 H, 2 Samet O4, 1 Samet 12, 1 Samet 13,
1 Samet 22, 1 Samet 24, 1 Samet 41
+ 2 Samet GR, 2 Samet XL

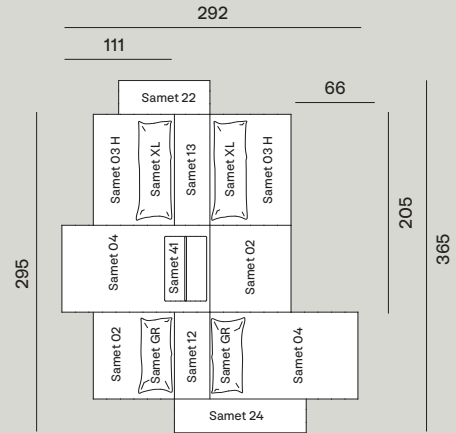

Samet Configuration H → P. 56-63

5 Samet O2, 4 Samet 12, 1 Samet 13
+ 4 Samet GR

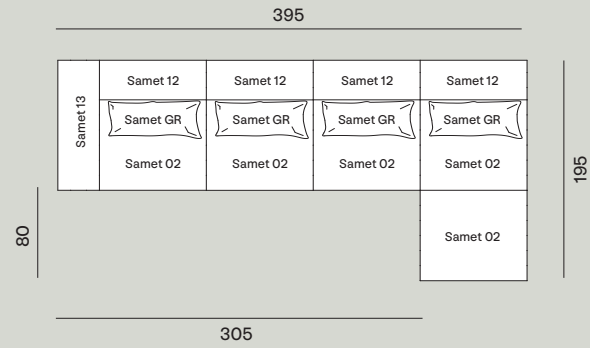

Samet Configuration I → P. 64-69

2 Samet O1, 4 Samet O2, 1 Samet O3 H, 2 Samet 11, 4 Samet 12, 2 Samet 13
+ 6 Samet GR

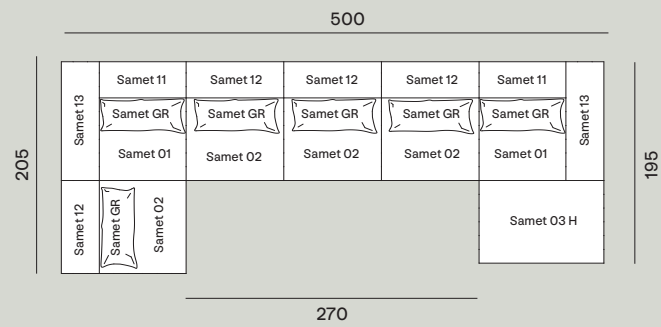

Samet Configuration L

2 Samet O2, 1 Samet O3 V, 2 Samet 12, 1 Samet 13
+ 2 Samet GR

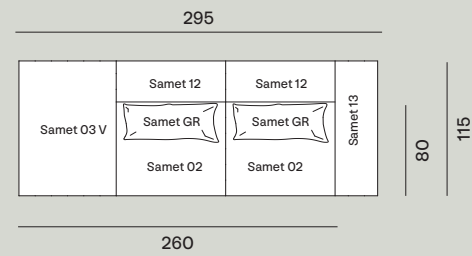

Samet Configuration M

2 Samet O2, 1 Samet O3 V, 1 Samet O4, 3 Samet 12, 1 Samet 23
+ 3 Samet GR

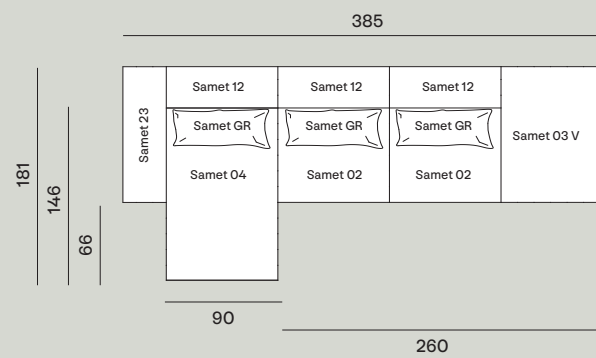

Sezione Samet Low / Samet Low Section

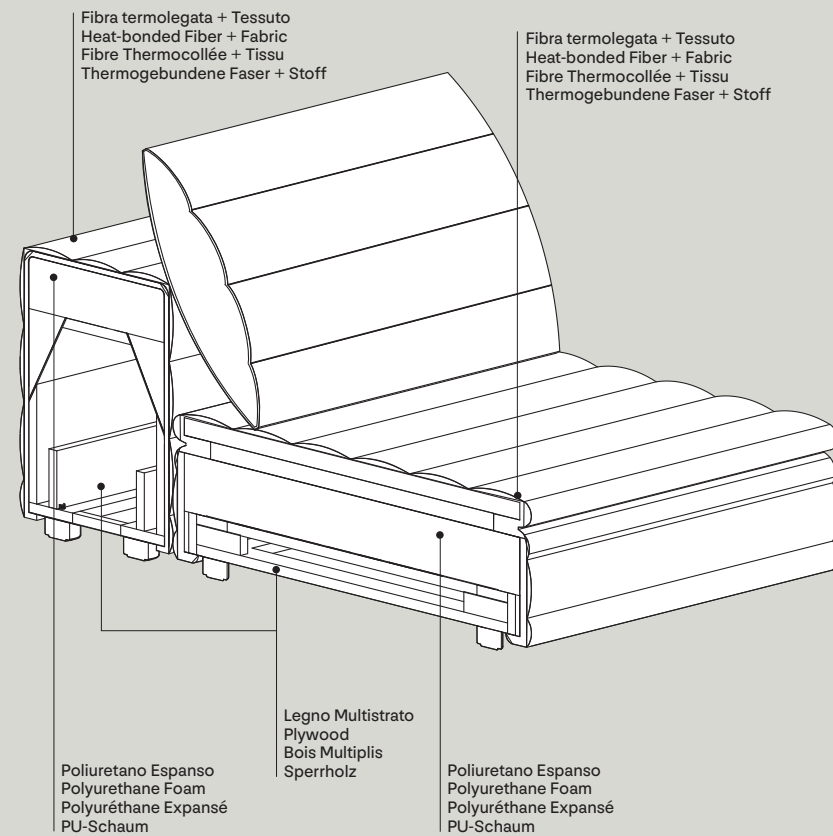

Struttura / Structure
/ Structure / Gestell

Struttura in legno multistrato preparata con poliuretano espanso a quote differenziate, localizzate, ad alta densità, al fine di migliorarne comfort, sofficià e durata. Topper fisso in poliuretano espanso a quote differenziate. Rivestimento della struttura e del topper in fibra termolegata traspirante accoppiata alla fodera in tessuto tramite trapuntatura. Piedi in polietilene ad alta resistenza, colore nero.

Structure in plywood made of high resilience, variable-density polyurethane foam, in order to improve comfort, softness and durability. Fixed variable-density polyurethane foam topper. Structure and topper covered with breathable heat-bonded fiber bonded to the fabric cover by quilting. Feet in high resistance black polyethylene.

Structure en bois multiplis associée à du polyuréthane expansé à densité différenciée haute résilience, garantissant confort, souplesse et longévité. Surmatelas fixe en polyuréthane expansé à densité différenciée. Revêtement de la structure et du surmatelas en fibre thermocollée respirante liée à la housse en tissu matelassé. Pieds en polyéthylène haute résistance, couleur noire.

Gestell aus Sperrholz, Polsterung aus PU-Schaum mit differenzierter, hoher Dichte, um Komfort, Weichheit und Langlebigkeit zu gewährleisten. Fest verbundener Topper aus PU-Schaum mit differenzierter Dichte. Weißpolsterbezug mit atmungsaktiver thermogebundener Faser gesteppt zusammen mit der Husse aus Stoff. Schwarze FüÙe aus widerstandsfähigem Polyethylen.

Cuscini / Cushions
/ Coussins / Kissen

I cuscini di schienale sono realizzati in fibra di poliestere di alta qualità che assicura il ripristino della forma originaria del cuscino dopo l'uso. Fodera in tessuto e fibra, trapuntate sul lato anteriore. Cuscini volanti con imbottitura in misto piuma.

Back cushions are made of high-quality polyester fiber, which ensures that the original shape of the pillow is restored after use. Fabric and fiber cover, quilted on the front side. Loose cushions with dacron and down filling.

Les coussins de dossier sont réalisés en fibres de polyester de haute qualité, ce qui permet de retrouver la forme originale du coussin après utilisation. Housse en tissu et en fibres, matelassée sur le devant. Coussins déco avec rembourrage en dacron et plumes.

Die Rückenkissen sind aus hochwertigen Polyesterfasern, die dafür sorgen, dass das Kissen nach dem Gebrauch seine ursprüngliche Form wieder erhält. Kissenbezug aus Stoff und Fasern, auf der Vorderseite gesteppt. Lose Kissen mit Polsterung aus Dacron und Daunen.

Sfoderabilità / Removable covers /
Housses amovibles / Abnehmbare Bezüge:

Ogni modulo è facilmente sfoderabile a garanzia di una facile e frequente pulizia del rivestimento.

Each module is completely and easily removable to guarantee easy and frequent cleaning of the cover.

Chaque élément est entièrement et facilement déhoussable permettant un nettoyage aisé et fréquent des housses.

Alle Elemente sind komplett abziehbar, was eine einfache und häufige Reinigung der Bezüge garantiert.

Samet Low 01

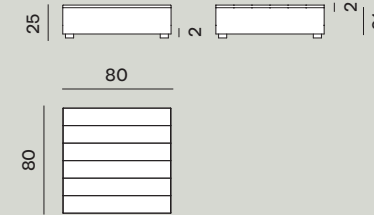

Samet Low 02

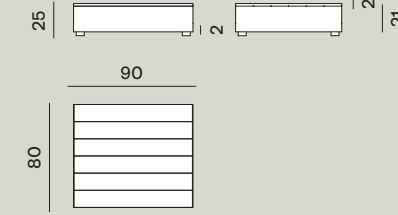

Samet Low 03 H

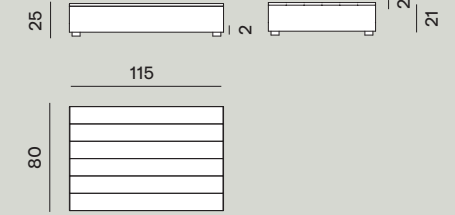

Samet Low 03 V

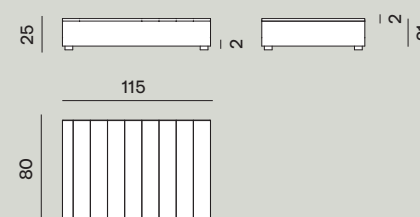

Samet Low 04

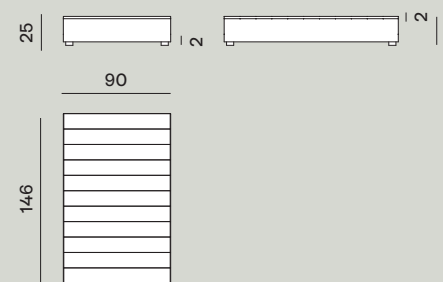

Samet Low 05

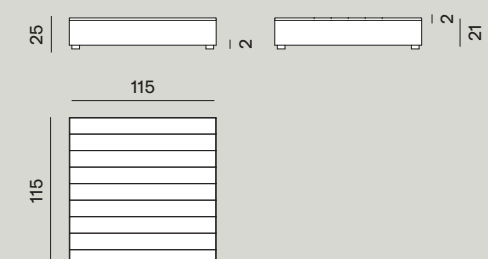

Samet Low 11

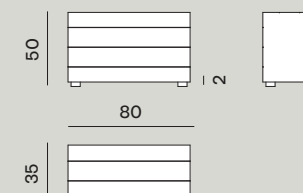

Samet Low 12

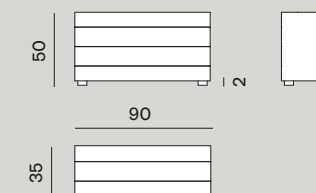

Samet Low 13

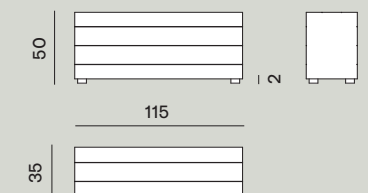

Samet Low 14

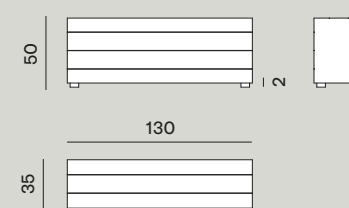

Samet Low 41

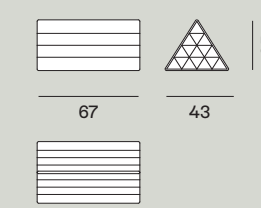

Samet Low 81

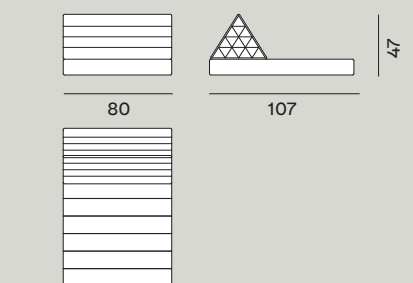

↳ Samet Low Modules

Samet Low GR

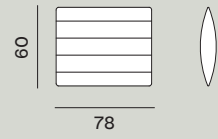

Samet Low XL

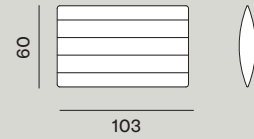

C. Samet Low XS



C. Samet Low M

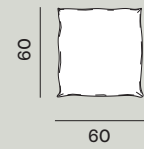

↳ Samet Low Configurations

Samet Low Configuration A → P. 78-85

6 Samet Low 02, 2 Samet Low 11, 3 Samet Low 12, 2 Samet Low 13
+ 3 Samet Low GR

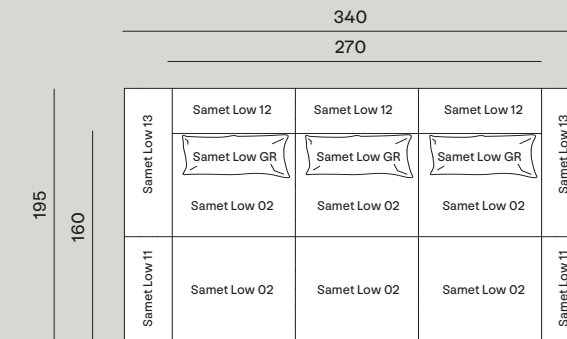

Samet Low Configuration B → P. 86-93

2 Samet Low 02, 1 Samet Low 03 V, 1 Samet Low 04, 3 Samet Low 12
+ 3 Samet Low GR

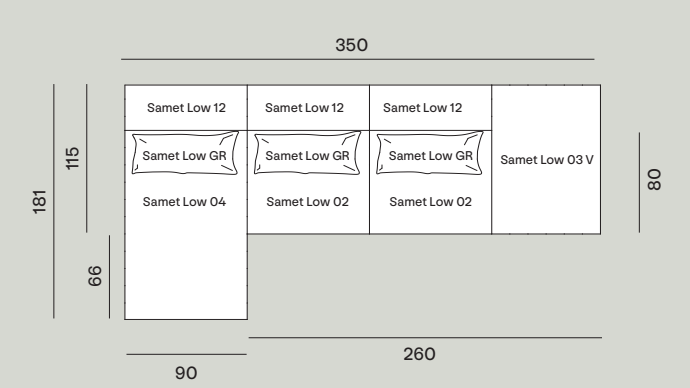

Samet Low Configuration C → P. 94-101

2 Samet Low 02, 2 Samet Low 05, 2 Samet Low 12, 1 Samet Low 41
+ 2 Samet Low GR

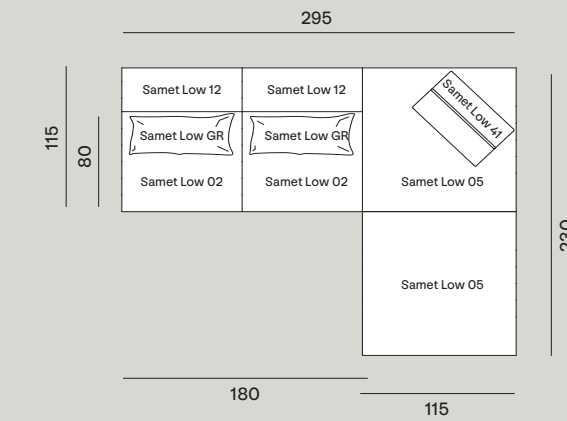

Samet Low Configuration D → P. 102-107

4 Samet Low 02, 1 Samet Low 11, 2 Samet Low 12, 1 Samet Low 13
+ 2 Samet Low GR

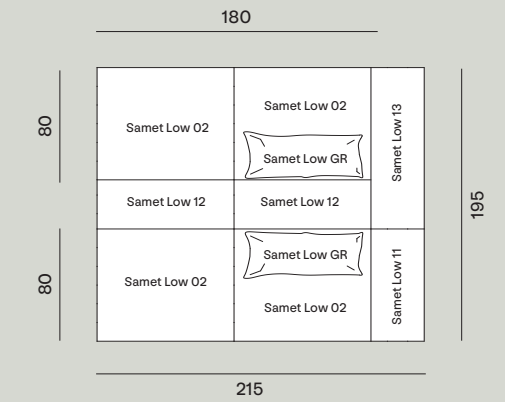

Samet Low Configuration E → P. 108-115

1 Samet Low 01, 3 Samet Low 02, 1 Samet Low 11, 3 Samet Low 12, 1 Samet Low 13
+ 2 Samet Low GR

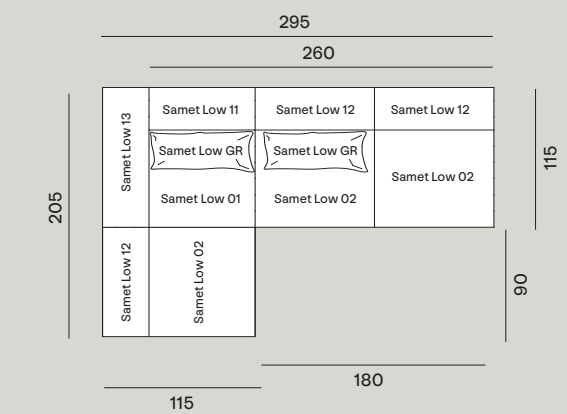

Samet Low Configuration F → P. 116-121

6 Samet Low 02, 3 Samet Low 41

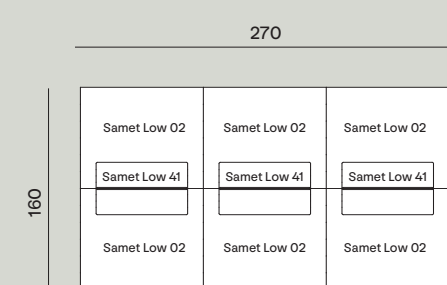

↳ Samet Low Configurations

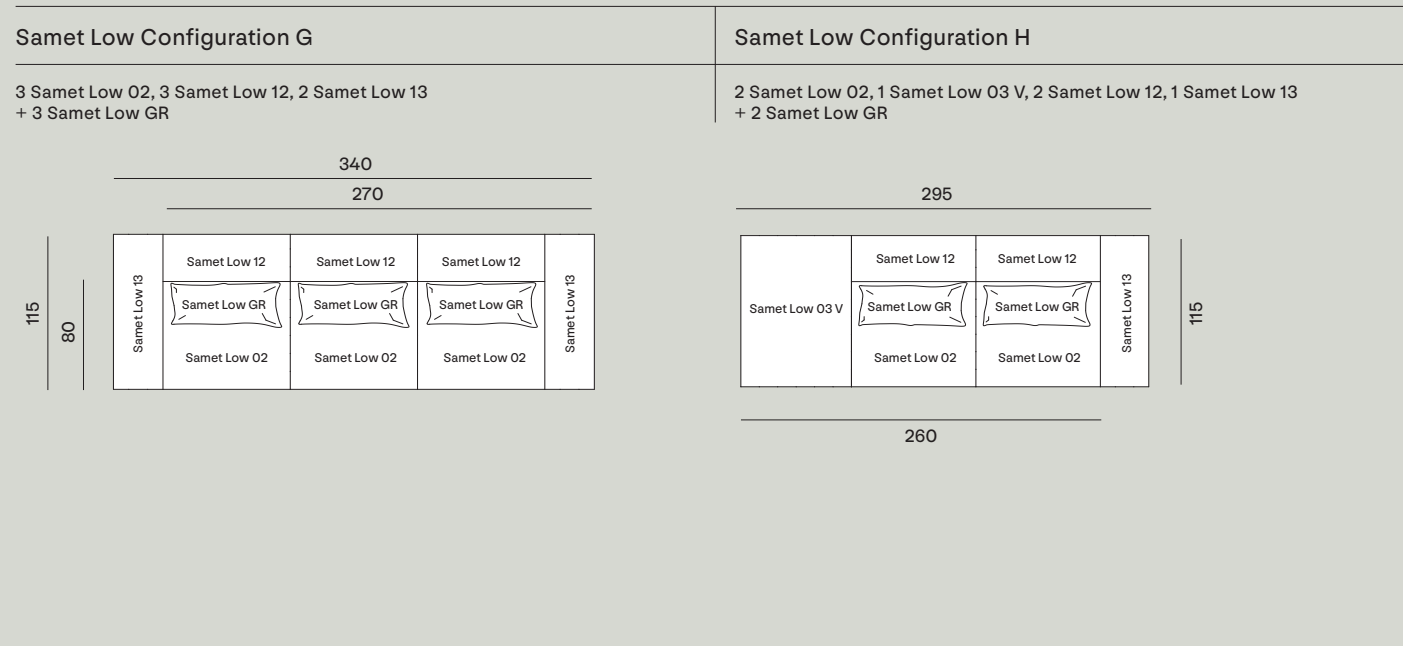

↳ Fastening System

I. Il fissaggio dei moduli avviene tramite staffe in metallo ad incastro che consentono un pratico e stabile collegamento tra sedute, schienali e braccioli. Tutte le configurazioni sono modificabili grazie al semplice sistema di aggancio che permette lo spostamento o l'aggiunta di ulteriori moduli.

E. The modules are fastened by means of interlocking metal brackets that provide a convenient and stable connection between seats, backs and armrests. All configurations are customisable thanks to the simple fastening system that allows further modules to be moved or added.

F. Les éléments sont fixés à l'aide de supports métalliques qui s'emboîtent les uns dans les autres et permettent une connexion pratique et stable entre les sièges, les dossiers et les accoudoirs. Toutes les configurations sont modifiables grâce au système de fixation simple qui permet de déplacer ou d'ajouter des modules supplémentaires.

D. Die Elemente werden mit Hilfe von ineinandergreifenden Metallbügeln zusammenbefestigt, die eine praktische und stabile Verbindung zwischen Sitz, Rücken- und Armlehnen ermöglichen. Dank des einfachen Befestigungssystems, das das Verschieben oder Hinzufügen weiterer Module ermöglicht, können alle Konfigurationen individuell verändert werden.

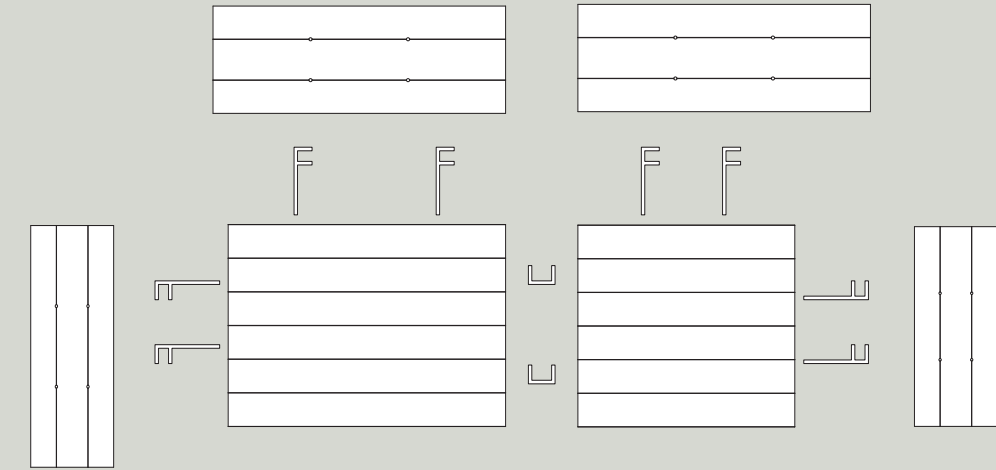

Staffe corte per l'aggancio tra i moduli di seduta.
/ Short connectors between seat modules.

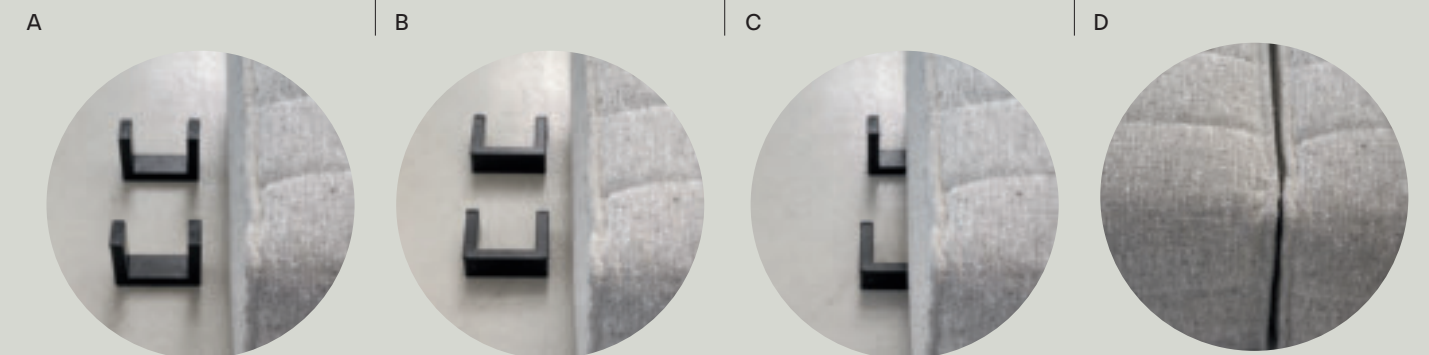

Staffe lunghe per l'aggancio tra i moduli di seduta e di schienale/bracciolo.
/ Long connectors between seat and back/armrest modules.

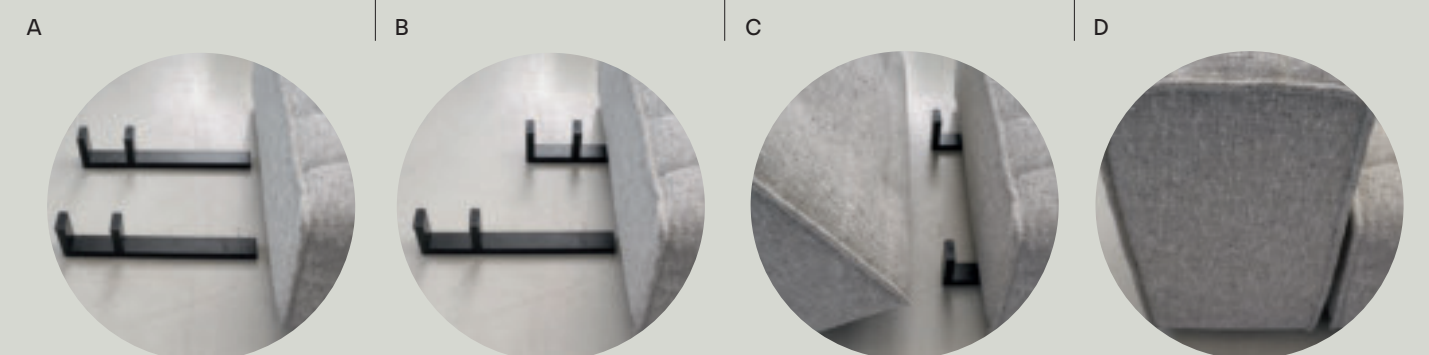

Credits:

Concept + Design:
Choice–Studio

Product design:
Federica Biasi

Photo:
Max Rommel

Styling:
Ilaria Baccocchi Studio

Printed in Italy:
Grafiche Antiga
Settembre 2023

Gervasoni spa
Viale del Lavoro, 88
33050 Pavia di Udine, Italy
ph. + 39 0432 656611
info@gervasoni1882.com
www.gervasoni1882.com

Thanks to:

Purho
www.purho.it

Silvia Garau
www.silviagarausculpture.com

Ilaria Franza
www.ilariafranza.com

Claire Lune
www.clairelune.it

Kanz Architetti
www.kanzarchitetti.com

Battilossi
www.battilossi.com

Oluce
www.oluce.com

GERVASONI®

1882

Gervasoni spa è dotata di un Sistema di Qualità Certificato UNI EN ISO 9001, di un Sistema per la gestione della Sicurezza e della Salute dei lavoratori Certificato ISO 45001 e di un Sistema di Gestione Ambientale Certificato UNI EN ISO 14001 / Gervasoni spa is certified to: UNI EN ISO 9001 Company Quality System Certification, ISO 45001 Certification for Health and Safety Management Systems and UNI EN ISO 14001 Environmental Management System Certification.



IDB

Gervasoni fa parte del gruppo Italian Design Brands /
Gervasoni is part of Italian Design Brands Group



CATSAMET23B

© Copyright 2023 Gervasoni S.p.A.
Tutti i diritti riservati

